

5W HI-POWER LED SPECIFICATION

HPD8b-49K5xWHBx



Drawn by	Checked by	Approved by



DATE:2012/3/9

REV:C



HUEY JANN ELECTRONICS INDUSTRY CO., LTD.

No.27 Line 466 Sec.2,Cannng-nan Rd. Wu-chi Town Taichung Shien, Taiwan, R.O.C.

TEL:+886-4-26393976 FAX:+886-4-26393125

HUEY JANN High Power 5W LED is made of GaInN chips with precise package technique which makes excellent heat dissipation to reach the advantages of high luminous efficiency, low decay, and long endurance. Now we have these colors available: red, green, blue, white, yellow and infrared.

☰ **FEATERUS**

- Instant light
- Long operating life
- Superior ESD defense
- Low voltage DC operated
- More energy efficient than incandescent and most halogen lamps

☰ **TYPICAL APPLICATIONS**

- Architectural detail lighting
- Portable flashlight
- Medical applications
- Beacon lights
- Decoration lights
- Spotlight



HUEY JANN ELECTRONICS INDUSTRY CO., LTD.

No.27 Line 466 Sec.2,Canng-nan Rd. Wu-chi Town Taichung Shien, Taiwan, R.O.C.

TEL:+886-4-26393976 FAX:+886-4-26393125

☰ Explanation of Part Number:

H P D 8 b - 4 9K 5 xWHBx / WPCB
① ② ③ ④ ⑤ ⑥ ⑦ ⑧ ⑨ ⑩

1.H: Huey Jann

2.P: High power LED Type

3.Shape distinguish:

B: Lambertian type S: Side emitting type
D: Focusing type E: Focusing type
R: Reflector type

4.Identification no:

5.Lead frame type

6.Appearance:

1:White Diffusion
4:Water Clear

7.Color number:

3K: Green 4K: Yellow
5K: Red 8K: Blue
9K: White

8.Power type:

Non: 1W 05: 0.5W
3: 3W 5: 5W

9.Color kind:

WHBx: Pure White
YWHBx(4000°K): Nature White
YWHBx: Warm White

10.Heat conduction type:

Non: emitter type
/WPCB: with white star type heat sink



HUEY JANN ELECTRONICS INDUSTRY CO., LTD.

No.27 Line 466 Sec.2,Cannng-nan Rd. Wu-chi Town Taichung Shien, Taiwan, R.O.C.

TEL:+886-4-26393976 FAX:+886-4-26393125

PACKAGE DIMENSIONS:

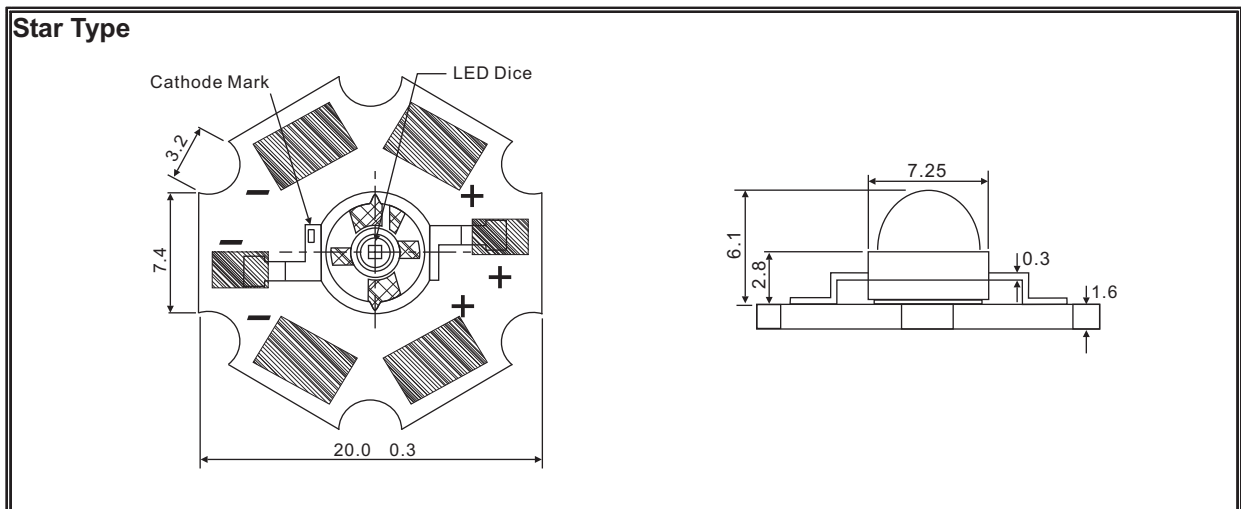
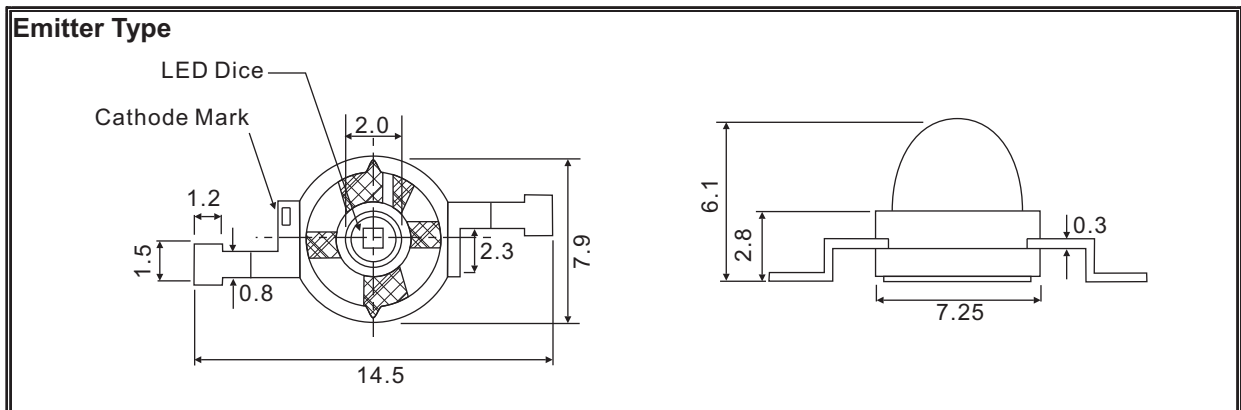

NOTE:

- 1.All dimensions are in millimeter.
- 2.Lead spacing is measured where the lead emerge from the package.
- 3.protruded resin under flange is 1.5mm max.
- 4.specifications are subject to change without notice.
- 5.Tolerance is 0.3mm unless otherwise noted.
- 6.Driving LED without heat sinking device is forbidden.
- 7.It is strongly recommended that the temperature of lead be not higher than 55°C.
- 8.Proper current derating must be observed to maintain junction temperature below the maximum.
- 9.LEDs are not designed to be driven in reserve bias.



HUEY JANN ELECTRONICS INDUSTRY CO., LTD.

No.27 Line 466 Sec.2,Cann-gan Rd. Wu-chi Town Taichung Shien, Taiwan, R.O.C.

TEL:+886-4-26393976 FAX:+886-4-26393125

☰ DEVICES

Item	Lens Color	Dice Source	Color Temperature Typ (°K)
HPD8b-49K5WHB	Water Clear	GaInN/GaN	6000
HPD8b-49K5WHB/WPCB			
HPD8b-49K5YWHB(4000°K)			4000
HPD8b-49K5YWHB/WPCB(4000°K)			
HPD8b-49K5YWHB(4000°K)/CRI 90			
HPD8b-49K5YWHB/WPCB(4000°K)/CRI 90			
HPD8b-49K5YWHB			3300
HPD8b-49K5YWHB/WPCB			
HPD8b-49K5YWHB/CRI 90			
HPD8b-49K5YWHB/WPCB/CRI 90			



HUEY JANN ELECTRONICS INDUSTRY CO., LTD.

No.27 Line 466 Sec.2,Cannng-nan Rd. Wu-chi Town Taichung Shien, Taiwan, R.O.C.

TEL:+886-4-26393976 FAX:+886-4-26393125

ABSOLUTE MAXIMUM RATINGS

TA=25°C

PARAMETER	SYMBOL	MAX. RATING	UNIT
Continuous Forward Current	IF	1400	mA
Peak Forward Current *1	IFM	1500	mA
Electrostatic Discharge(HBM)	ESD	4000	V
LED Junction Temperature	Tj	135	°C
Operating Temperature	Topr	-40 ~ +110	°C
Storage Temperature	Tstg	-40 ~ +120	°C
Manual Soldering Temperature 260 °C for 5 seconds max. *2 *3			

*1.Duty Ratio=0.1%,Pulse Width=10us.

*2.Iron soldering high temperature will not cause damage to the dice. But be aware of the high temperature will not only make the epoxy soften but also cause the lead moving and the gold wire broken and even open. So before returning to the normal temperatures PLEASE AVOID any serious pressure on the top of epoxy and lead.

*3.Measured at leads, lens temperature must not exceed 120°C during lead soldering and slug attach. Soldering by general IR reflow, Vapor phase reflow and wave soldering on this system product is unsuitable. Selective heating of the leads limit lead soldering, such as by hot bar reflow, fiber focussed IR, or hand soldering. The package back plane (slug) may not be attached by soldering, but rather with a thermally conductive adhesive. Electrical insulation between the slug and the board is necessary. Please consult welding matters needing attention.



HUEY JANN ELECTRONICS INDUSTRY CO., LTD.

No.27 Line 466 Sec.2,Cannng-nan Rd. Wu-chi Town Taichung Shien, Taiwan, R.O.C.

TEL:+886-4-26393976 FAX:+886-4-26393125

ELECTRIC-OPTICAL CHARACTERISTICS IN COMMON

TA=25°C

Parameter	Symbol	Test Condition	Typ	Max	Unit
View Angle of Half Power	2θ _{1/2}	IF=1400mA	45		deg
Forward Voltage	V _F		4.2	4.5	V
Thermal Resistance Junction To Case	R _{θ J-C}		8		°C/W
Thermal Resistance Junction To Case With Star Type Heat Sink	R _{θ J-C}		11		°C/W
Temperature Coefficient Of Forward Voltage	ΔV _F /ΔT		-2		mV/°C

ELECTRIC-OPTICAL CHARACTERISTICS TO BE INDEPENDENT

IF=1400mA TA=25°C

Item	CCT (°K)	CRI (Ra)	Brightness (lm)
	Typical		
HPD8b-49K5WHB	6000	75	340
HPD8b-49K5WHB/WPCB			
HPD8b-49K5YWHB(4000°K)	4000	72	320
HPD8b-49K5YWHB/WPCB(4000°K)			
HPD8b-49K5YWHB(4000°K)/CRI 90		90	260
HPD8b-49K5YWHB/WPCB(4000°K)/CRI 90			
HPD8b-49K5YWHB	3300	70	305
HPD8b-49K5YWHB/WPCB			
HPD8b-49K5YWHB/CRI 90		90	250
HPD8b-49K5YWHB/WPCB/CRI 90			



HUEY JANN ELECTRONICS INDUSTRY CO., LTD.

No.27 Line 466 Sec.2,Cannng-nan Rd. Wu-chi Town Taichung Shien, Taiwan, R.O.C.

TEL:+886-4-26393976 FAX:+886-4-26393125

RELIABILITY TEST

➤ Endurance Test

Test Item	Reference Standard	Test Conditions	Result
Operation Life	MIL-STD-750:1026 MIL-STD-883:1005 JIS-C-7021 :B-1	Connect with a power if=1400mA Ta=Under room temperature Test Time=1,000hrs	0/22
High Temperature High Humidity Storage	MIL-STD-202:103B JIS-C-7021 :B-11	Ta=+85°C 5°C RH=80% ~ 85% Test Time=1,000hrs	0/22
High Temperature Storage	MIL-STD-883:1008 JIS-C-7021 :B-10	High Ta=+120°C 5°C Test Time=1,000hrs	0/22
Low Temperature Storage	JIS-C-7021 :B-12	Low Ta=-40°C 5°C Test Time=1,000hrs	0/22

*Failure Criteria:

1. VF arise $\geq 10\%$
2. IV decline $\geq 30\%$
3. A failure is an LED that is open or shorted



HUEY JANN ELECTRONICS INDUSTRY CO., LTD.

No.27 Line 466 Sec.2,Cannng-nan Rd. Wu-chi Town Taichung Shien, Taiwan, R.O.C.

TEL:+886-4-26393976 FAX:+886-4-26393125

RELIABILITY TEST

➤ Environmental Test

Test Item	Reference Standard	Test Conditions	Result
Temperature Cycling	MIL-STD-202:107D MIL-STD-750:1051 MIL-STD-883:1010 JIS-C-7021 :A-4	-40°C ~ +25°C ~ +85°C ~ +25°C 60min 20min 60min 20min Test Time=200cycle	0/22
Thermal Shock	MIL-STD-202:107D MIL-STD-750:1051 MIL-STD-883:1010	-40°C 5°C ~ +110°C 5°C 20min 20min Test Time=200cycle	0/22

*Failure Criteria:

1. VF arise \geq 10%
2. IV decline \geq 30%
3. A failure is an LED that is open or shorted



HUEY JANN ELECTRONICS INDUSTRY CO., LTD.

No.27 Line 466 Sec.2,Canng-nan Rd. Wu-chi Town Taichung Shien, Taiwan, R.O.C.

TEL:+886-4-26393976 FAX:+886-4-26393125

TYPICAL ELECTRICAL OPTICAL CHARACTERISTICS CURVES

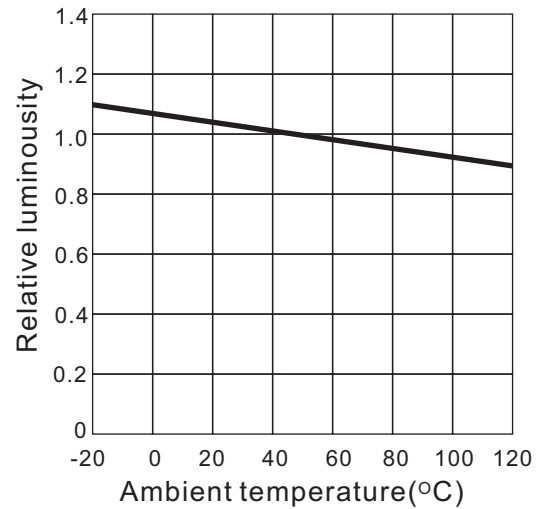
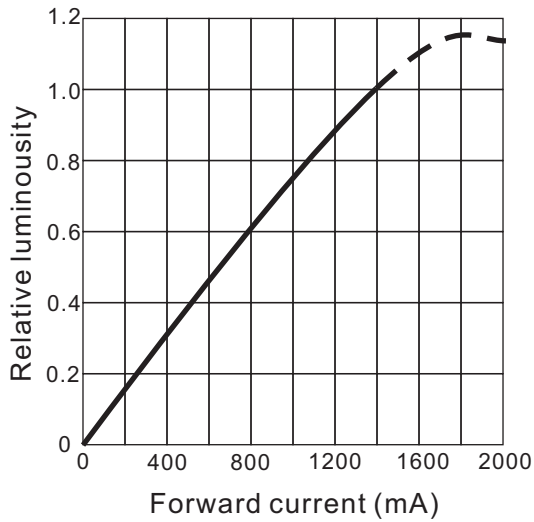
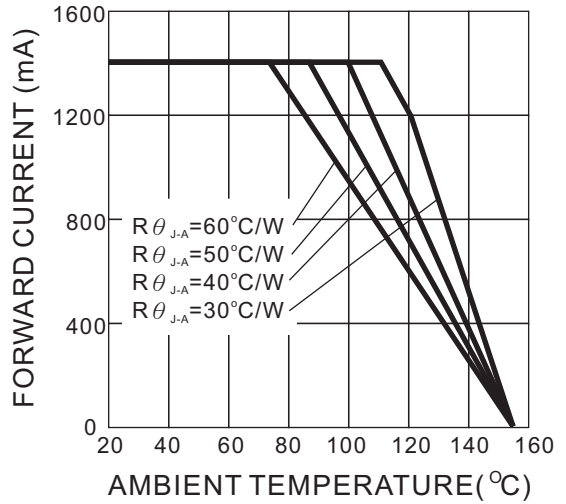
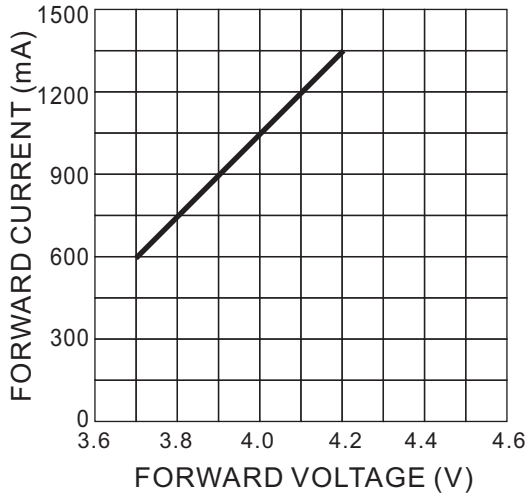

HUEY JANN ELECTRONICS INDUSTRY CO., LTD.

No.27 Line 466 Sec.2,Cannng-nan Rd. Wu-chi Town Taichung Shien, Taiwan, R.O.C.

TEL:+886-4-26393976 FAX:+886-4-26393125

TYPICAL ELECTRICAL OPTICAL CHARACTERISTICS CURVES

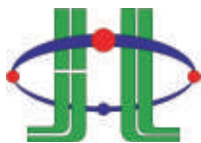
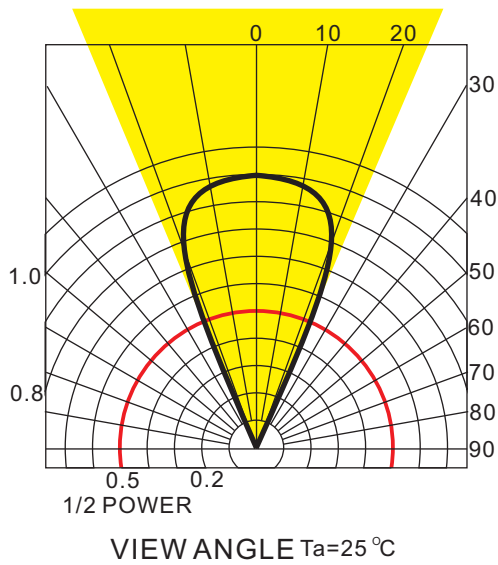
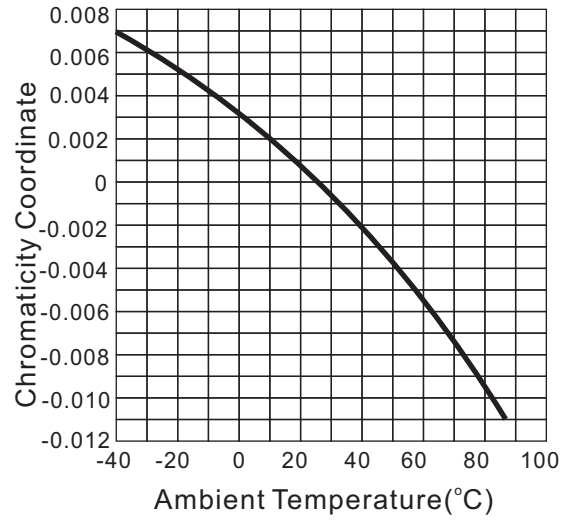
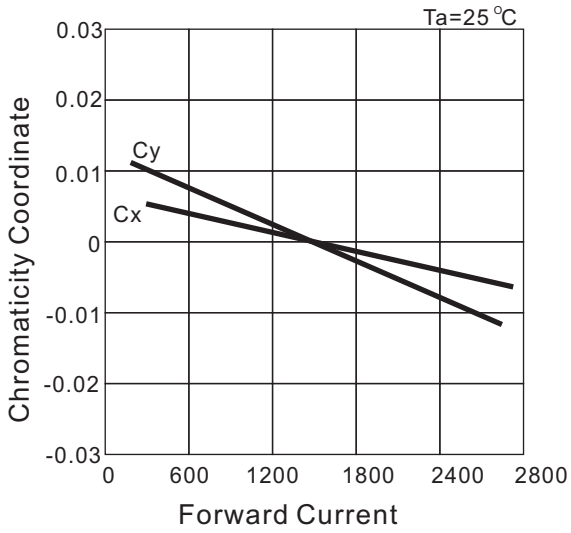

HUEY JANN ELECTRONICS INDUSTRY CO., LTD.

No.27 Line 466 Sec.2,Canng-nan Rd. Wu-chi Town Taichung Shien, Taiwan, R.O.C.

TEL:+886-4-26393976 FAX:+886-4-26393125

TYPICAL ELECTRICAL OPTICAL CHARACTERISTICS CURVES

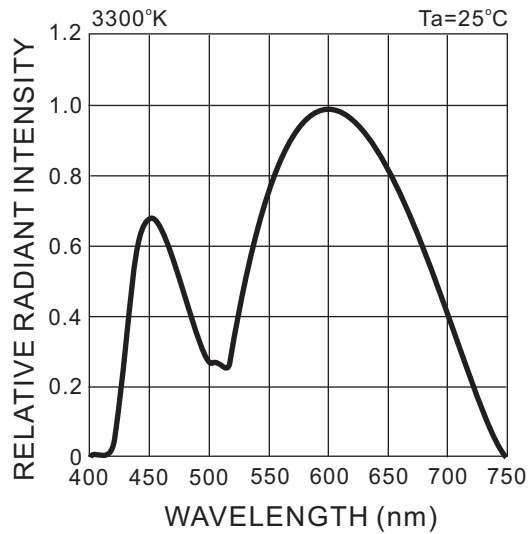
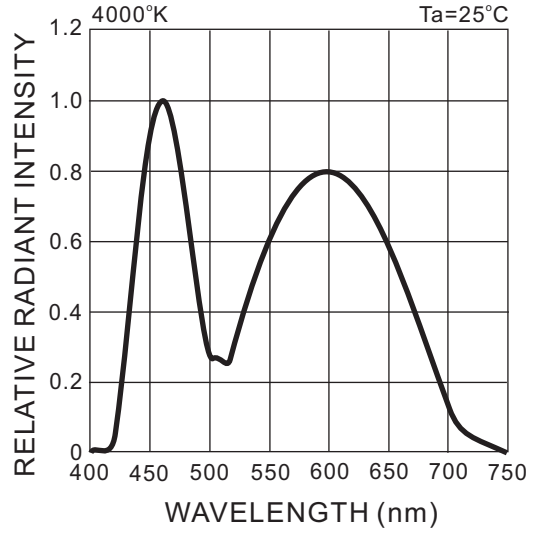
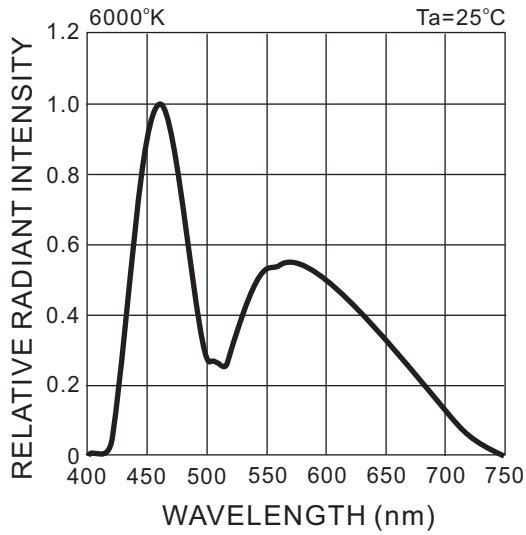

HUEY JANN ELECTRONICS INDUSTRY CO., LTD.

No.27 Line 466 Sec.2,Canng-nan Rd. Wu-chi Town Taichung Shien, Taiwan, R.O.C.

TEL:+886-4-26393976 FAX:+886-4-26393125

LED VF Bin Selection

BIN CODE	Forward Voltage	
	Minimum	Maximum
p	4.0	4.2
q	4.2	4.4
r	4.4	4.6

NOTE:

Test Condition at IF=1400mA.

Brightness Bin Selection

Item	BIN CODE	Brightness in lm	
		Minimum	Maximum
HPD8b-49K5WHB	R	310	410
HPD8b-49K5WHB/WPCB			
HPD8b-49K5YWHB(4000°K)	R	310	410
HPD8b-49K5YWHB/WPCB(4000°K)			
HPD8b-49K5YWHB(4000°K)/CRI 90	Q	240	310
HPD8b-49K5YWHB/WPCB(4000°K)/CRI 90			
HPD8b-49K5YWHB	Q	240	310
HPD8b-49K5YWHB/WPCB			
HPD8b-49K5YWHB/CRI 90	Q	240	310
HPD8b-49K5YWHB/WPCB/CRI 90			

NOTE:

1. Test Condition at IF=1400mA.



HUEY JANN ELECTRONICS INDUSTRY CO., LTD.

No.27 Line 466 Sec.2,Canng-nan Rd. Wu-chi Town Taichung Shien, Taiwan, R.O.C.

TEL:+886-4-26393976 FAX:+886-4-26393125

Pure White Color Bin Selection

Bin	CCT(°K)		Chromaticity Coordinates			
	TYP					
T1	9000	x	0.274	0.292	0.299	0.283
		y	0.301	0.322	0.300	0.284
T2	9000	x	0.283	0.299	0.303	0.290
		y	0.284	0.300	0.283	0.270
T3	8000	x	0.292	0.303	0.308	0.299
		y	0.322	0.333	0.311	0.300
T4	8000	x	0.299	0.308	0.311	0.303
		y	0.300	0.311	0.293	0.283
T5	6700	x	0.301	0.314	0.316	0.305
		y	0.342	0.355	0.333	0.322
T6	6700	x	0.305	0.316	0.317	0.308
		y	0.322	0.333	0.320	0.311
T7	6700	x	0.308	0.317	0.319	0.311
		y	0.311	0.320	0.300	0.293
T8	6000	x	0.314	0.329	0.329	0.316
		y	0.355	0.369	0.345	0.333
T9	6000	x	0.316	0.329	0.329	0.317
		y	0.333	0.345	0.331	0.320
T10	6000	x	0.317	0.329	0.329	0.319
		y	0.320	0.331	0.310	0.300
T11	5300	x	0.329	0.348	0.346	0.329
		y	0.369	0.385	0.359	0.345
T12	5300	x	0.329	0.346	0.329	0.344
		y	0.345	0.359	0.331	0.344
T13	5300	x	0.344	0.329	0.343	0.329
		y	0.344	0.331	0.331	0.320
T14	4750	x	0.348	0.367	0.362	0.346
		y	0.385	0.400	0.372	0.359
T15	4750	x	0.346	0.362	0.360	0.344
		y	0.359	0.372	0.357	0.344



HUEY JANN ELECTRONICS INDUSTRY CO., LTD.

No.27 Line 466 Sec.2,Canng-nan Rd. Wu-chi Town Taichung Shien, Taiwan, R.O.C.

TEL:+886-4-26393976 FAX:+886-4-26393125

Pure White Color Bin Selection

CIE Light Color Chart

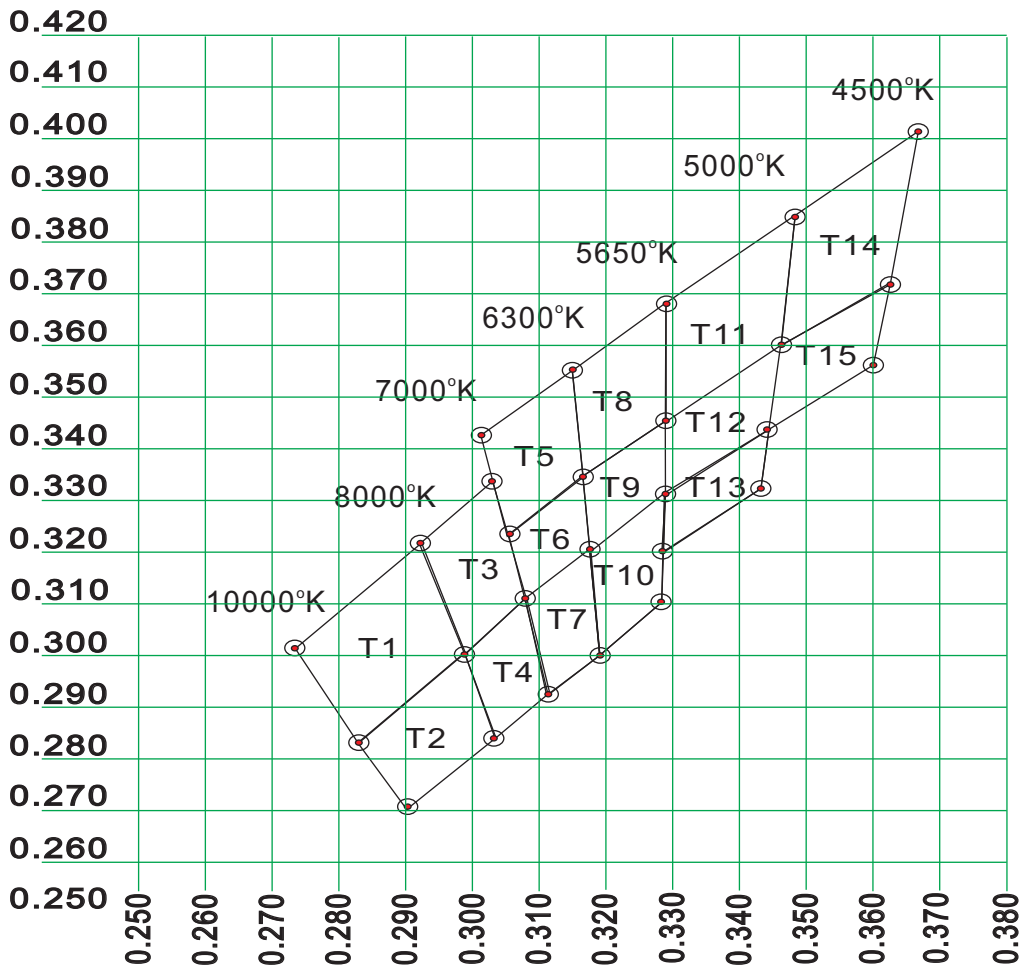

HUEY JANN ELECTRONICS INDUSTRY CO., LTD.

No.27 Line 466 Sec.2, Canning-nan Rd. Wu-chi Town Taichung Shien, Taiwan, R.O.C.

TEL:+886-4-26393976 FAX:+886-4-26393125

Nature White Color Bin Selection

Bin	CCT(°K)	Chromaticity Coordinates				
	TYP					
N1	4300	x	0.367	0.385	0.381	0.364
		y	0.400	0.412	0.393	0.382
N2	4300	x	0.364	0.381	0.378	0.362
		y	0.382	0.393	0.382	0.371
N3	4300	x	0.362	0.378	0.374	0.359
		y	0.371	0.382	0.365	0.355
N4	4300	x	0.359	0.374	0.370	0.357
		y	0.355	0.365	0.351	0.342
N5	3950	x	0.385	0.402	0.396	0.381
		y	0.412	0.422	0.403	0.393
N6	3950	x	0.381	0.396	0.392	0.378
		y	0.393	0.403	0.390	0.382
N7	3950	x	0.378	0.392	0.387	0.374
		y	0.382	0.390	0.373	0.365
N8	3950	x	0.370	0.387	0.382	0.357
		y	0.351	0.373	0.359	0.342
N9	3650	x	0.402	0.420	0.414	0.396
		y	0.422	0.432	0.416	0.403
N10	3650	x	0.396	0.414	0.408	0.392
		y	0.403	0.416	0.399	0.390
N11	3650	x	0.392	0.408	0.402	0.387
		y	0.390	0.399	0.382	0.373
N12	3650	x	0.387	0.402	0.396	0.382
		y	0.373	0.382	0.367	0.359



HUEY JANN ELECTRONICS INDUSTRY CO., LTD.

No.27 Line 466 Sec.2,Cannng-nan Rd. Wu-chi Town Taichung Shien, Taiwan, R.O.C.

TEL:+886-4-26393976 FAX:+886-4-26393125

Nature White Color Bin Selection

CIE Light Color Chart

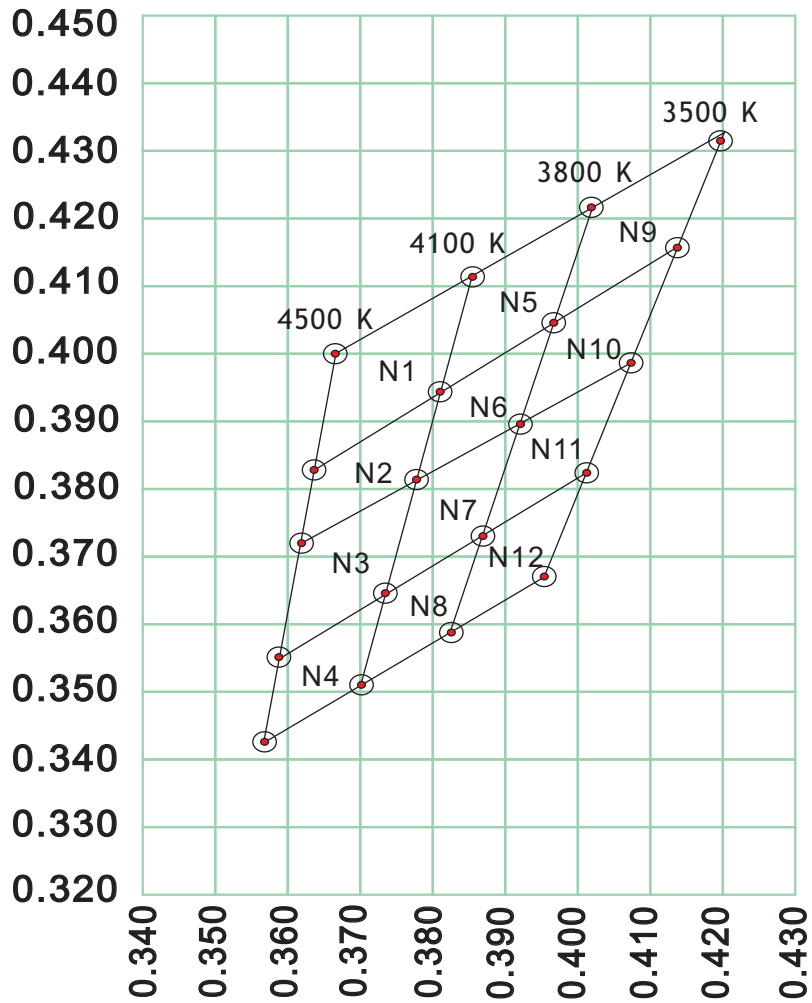

HUEY JANN ELECTRONICS INDUSTRY CO., LTD.

No.27 Line 466 Sec.2,Canng-nan Rd. Wu-chi Town Taichung Shien, Taiwan, R.O.C.

TEL:+886-4-26393976 FAX:+886-4-26393125

Warm White Color Bin Selection

Bin	CCT(°K)	Chromaticity Coordinates				
	TYP	x	y	z	u	v
C10	3640	x	0.402	0.417	0.409	0.392
		y	0.423	0.431	0.400	0.391
C11	3500	x	0.402	0.438	0.424	0.392
		y	0.423	0.440	0.406	0.391
C12	3640	x	0.392	0.409	0.402	0.387
		y	0.391	0.400	0.382	0.374
C13	3370	x	0.409	0.424	0.416	0.402
		y	0.400	0.406	0.389	0.382
C14	3500	x	0.387	0.416	0.410	0.383
		y	0.374	0.389	0.374	0.360
C15	3150	x	0.438	0.454	0.438	0.424
		y	0.440	0.446	0.412	0.406
C16	3150	x	0.424	0.438	0.429	0.416
		y	0.406	0.412	0.394	0.389
C17	2950	x	0.454	0.471	0.453	0.438
		y	0.446	0.451	0.416	0.412
C18	2950	x	0.438	0.453	0.444	0.429
		y	0.412	0.416	0.399	0.394



HUEY JANN ELECTRONICS INDUSTRY CO., LTD.

No.27 Line 466 Sec.2,Canng-nan Rd. Wu-chi Town Taichung Shien, Taiwan, R.O.C.

TEL:+886-4-26393976 FAX:+886-4-26393125

Warm White Color Bin Selection

➤ CIE Light Color Chart

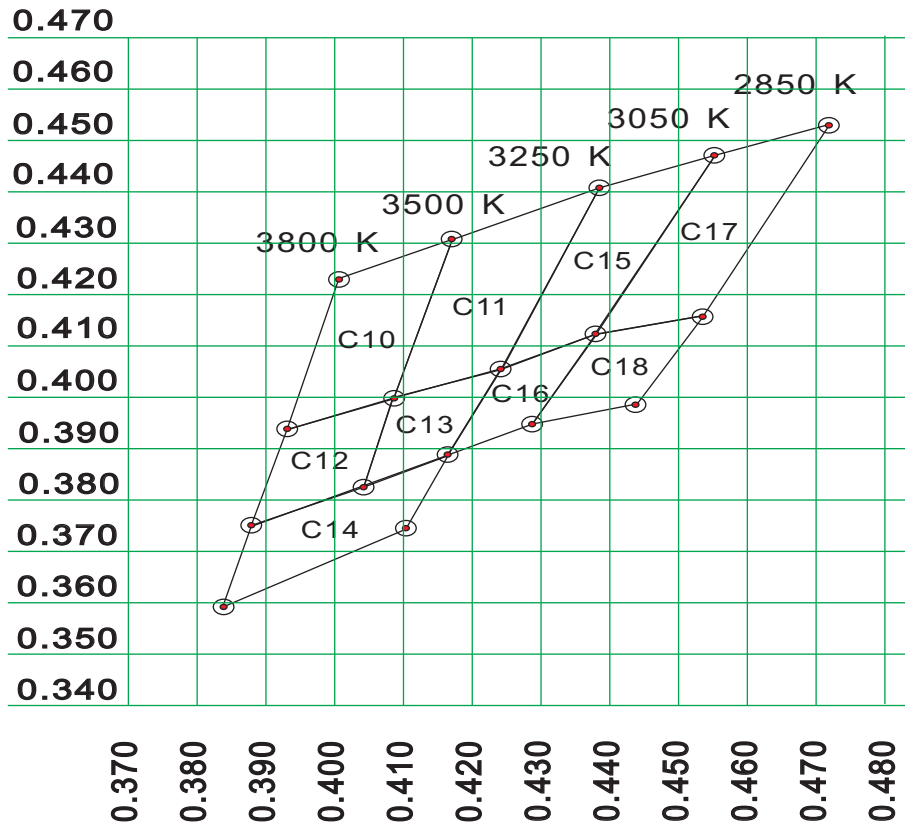

HUEY JANN ELECTRONICS INDUSTRY CO., LTD.

No.27 Line 466 Sec.2,Canng-nan Rd. Wu-chi Town Taichung Shien, Taiwan, R.O.C.

TEL:+886-4-26393976 FAX:+886-4-26393125

Package Dimension For Emitter Type

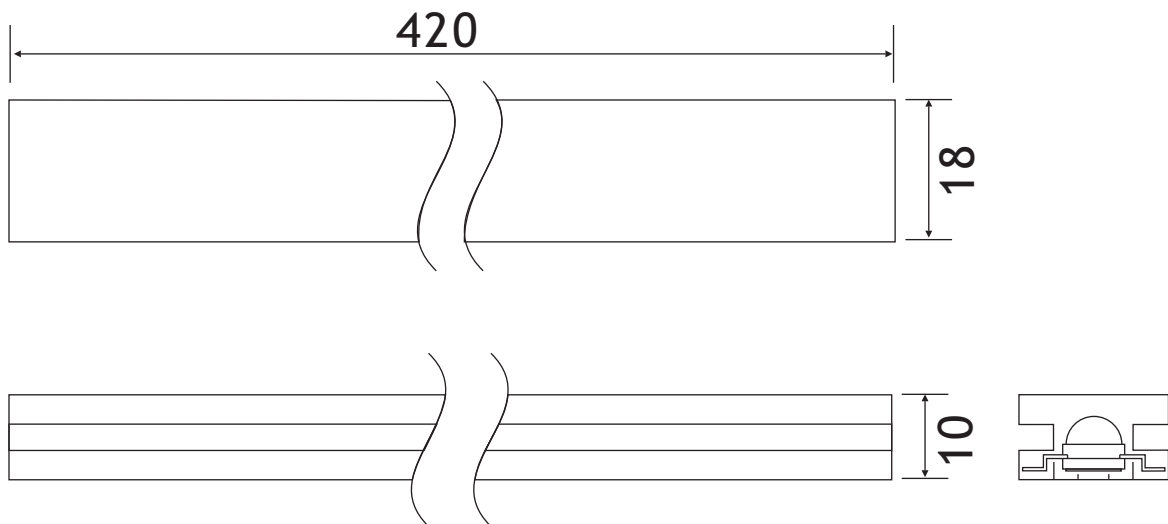

NOTE:

1. Dimensions are specified as follows: mm.
2. Tolerance is 0.3mm unless otherwise noted.
3. 50 pcs emitters per tube.
4. 80 tubes per inside box.
5. 4 inside box per outside box.



HUEY JANN ELECTRONICS INDUSTRY CO., LTD.

No.27 Line 466 Sec.2, Canning-nan Rd. Wu-chi Town Taichung Shien, Taiwan, R.O.C.

TEL:+886-4-26393976 FAX:+886-4-26393125

Package Dimension For Star Type

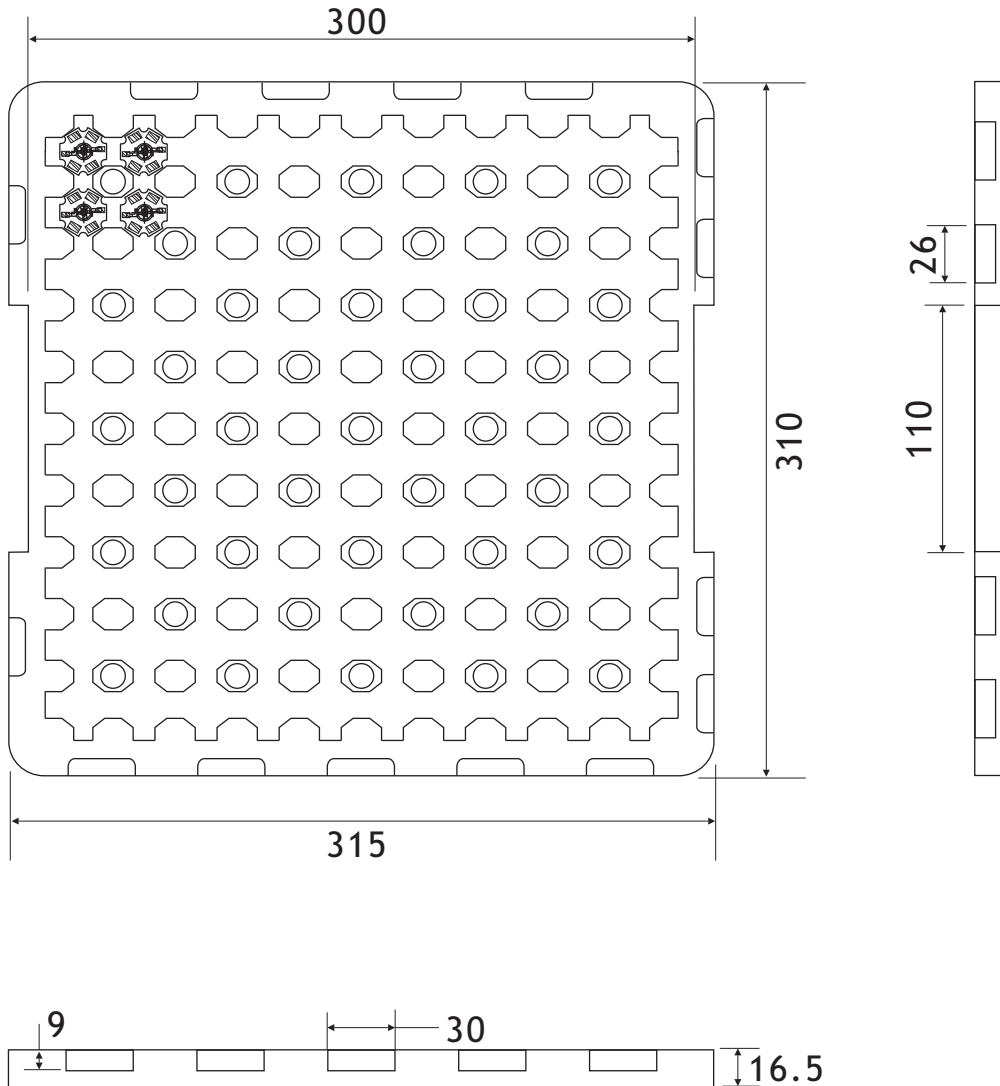

NOTE:

1. Dimensions are specified as follows: mm.
2. Tolerance is 0.3mm unless otherwise noted.
3. 100pcs star per tray.
4. 10 trays per box.



HUEY JANN ELECTRONICS INDUSTRY CO., LTD.

No.27 Line 466 Sec.2,Canng-nan Rd. Wu-chi Town Taichung Shien, Taiwan, R.O.C.

TEL:+886-4-26393976 FAX:+886-4-26393125

Requirements to user For Emitter Type

The LED products by HUEY-JANN is designed, manufactured, and sold aiming at high standard quality and reliability, however, reliability of electronic apparatus is seen as a product of reliability superior to HUEY-JANN and using status at users. From this point, HUEY-JANN requests user's for following things.

Recommended Solder Pad Design For Emitter Type

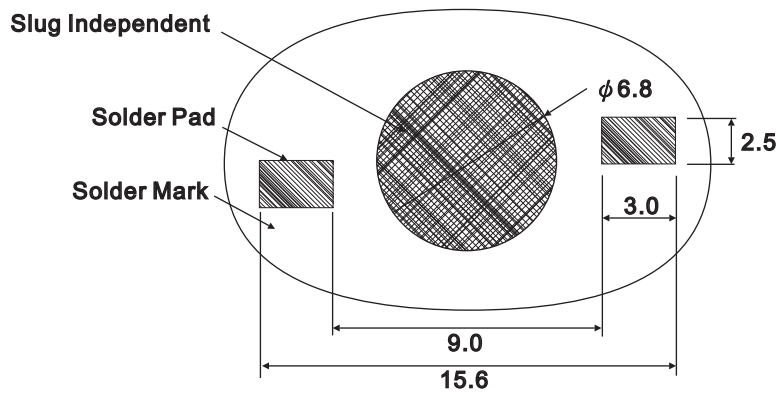

Note:

- 1.All dimensions are in millimeters.
- 2.Electrical isolation is required between Slug and Solder Pad.



HUEY JANN ELECTRONICS INDUSTRY CO., LTD.

No.27 Line 466 Sec.2,Cannng-nan Rd. Wu-chi Town Taichung Shien, Taiwan, R.O.C.

TEL:+886-4-26393976 FAX:+886-4-26393125

Heat Plate Soldering Condition For Emitter Type

a. Soldering Process for Solder Paste

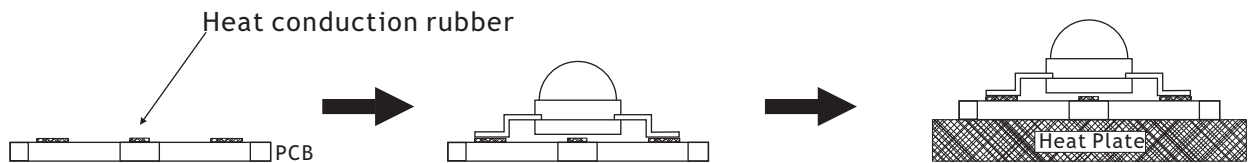

Use Solder Mask to print Solder Paste on PCB.

Place Emitter on PCB.

Put PCB on Heat Plate until Solder Paste melt.

- 1.The Solder Paste could be melted within 10 seconds.
- 2.Take out PCB out from Heat Plate within 15 seconds.

b. Soldering Process for Solder Wire

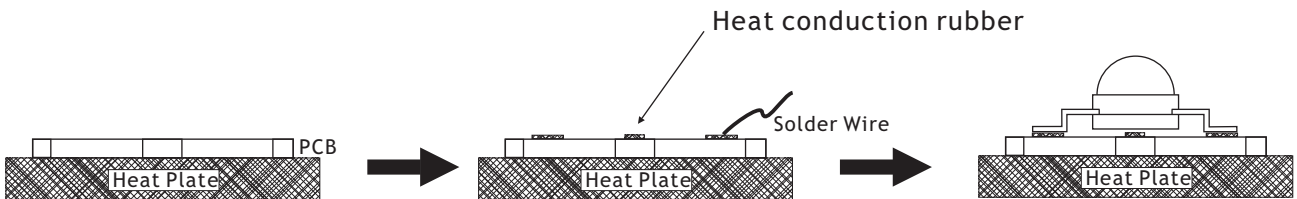

Put PCB on Heat Plate.

Place Solder Wire to the solder pad of PCB.

Put Emitter on PCB. Take the PCB out from Heat Plate within 10 seconds.

NOTE:

- 1.Heat plate temperature: 230°C max for Lead Solder and 260 °C max for Lead-Free Solder.
- 2.When soldering, do not put stress on the LEDs during heating.
- 3.After soldering, do not warp the circuit board.



HUEY JANN ELECTRONICS INDUSTRY CO., LTD.

No.27 Line 466 Sec.2,Cannng-nan Rd. Wu-chi Town Taichung Shien, Taiwan, R.O.C.

TEL:+886-4-26393976 FAX:+886-4-26393125

Soldering Process For Hot Bar For Emitter Type

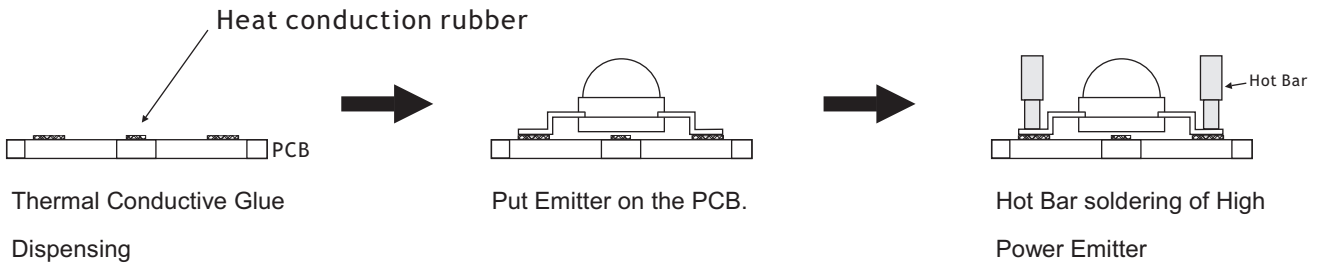

NOTE:

1. Hot Bar temperature: 230°C max for Lead Solder and 260°C max for Lead-Free Solder.
2. When soldering, do not put stress on the LEDs during heating.
3. After soldering, do not warp the circuit board.

Manual Hand Soldering For Emitter Type

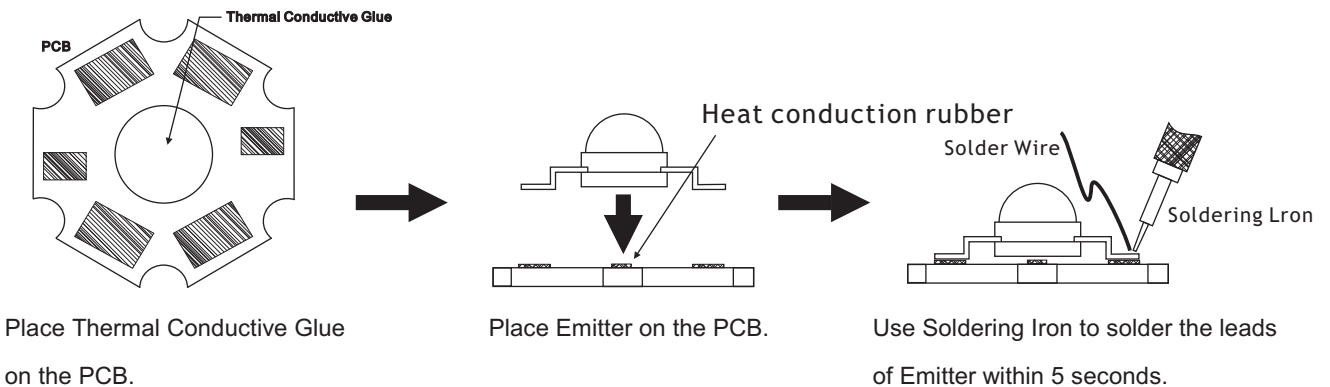

1. Solder tip temperature: 230°C max for Lead Solder and 260°C max for Lead-Free Solder.
2. Avoiding damage to the emitter or to the PCB dielectric layer. Damage to the epoxy layer can cause
3. Do not let the solder contact from solder pad to back-side of PCB. This one will cause a short circuit and damage emitter.



HUEY JANN ELECTRONICS INDUSTRY CO., LTD.

No.27 Line 466 Sec.2, Canning-nan Rd. Wu-chi Town Taichung Shien, Taiwan, R.O.C.

TEL:+886-4-26393976 FAX:+886-4-26393125

Conclusion

Huey Jann provide simple comparison table for High Power LED, you could find your request heat dissipation area from the following table.

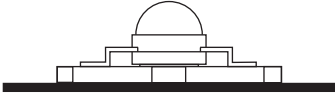
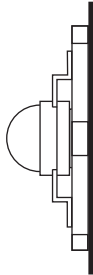
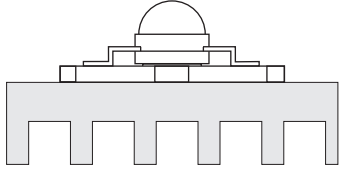
	 <p>Free Convection Horizontal Flat Heat Dissipation-Set-up (Area Require mm²)</p>	 <p>Free Convection Vertical Flat Heat Dissipation-Set-up (Area Require mm²)</p>	 <p>Free Convection Finned Heat Dissipation-Set-up (Area Require mm²)</p>
5W	9,000	7,500	12,000

*TAB in this table is according to highest operating temperature 65°C.

*Different materials of second heat dissipation device, the surface area of heat sink will be different. Thus, this document is for reference only.



HUEY JANN ELECTRONICS INDUSTRY CO., LTD.

No.27 Line 466 Sec.2,Cannng-nan Rd. Wu-chi Town Taichung Shien, Taiwan, R.O.C.

TEL:+886-4-26393976 FAX:+886-4-26393125

TAB Temperature - Life Characteristics Curves

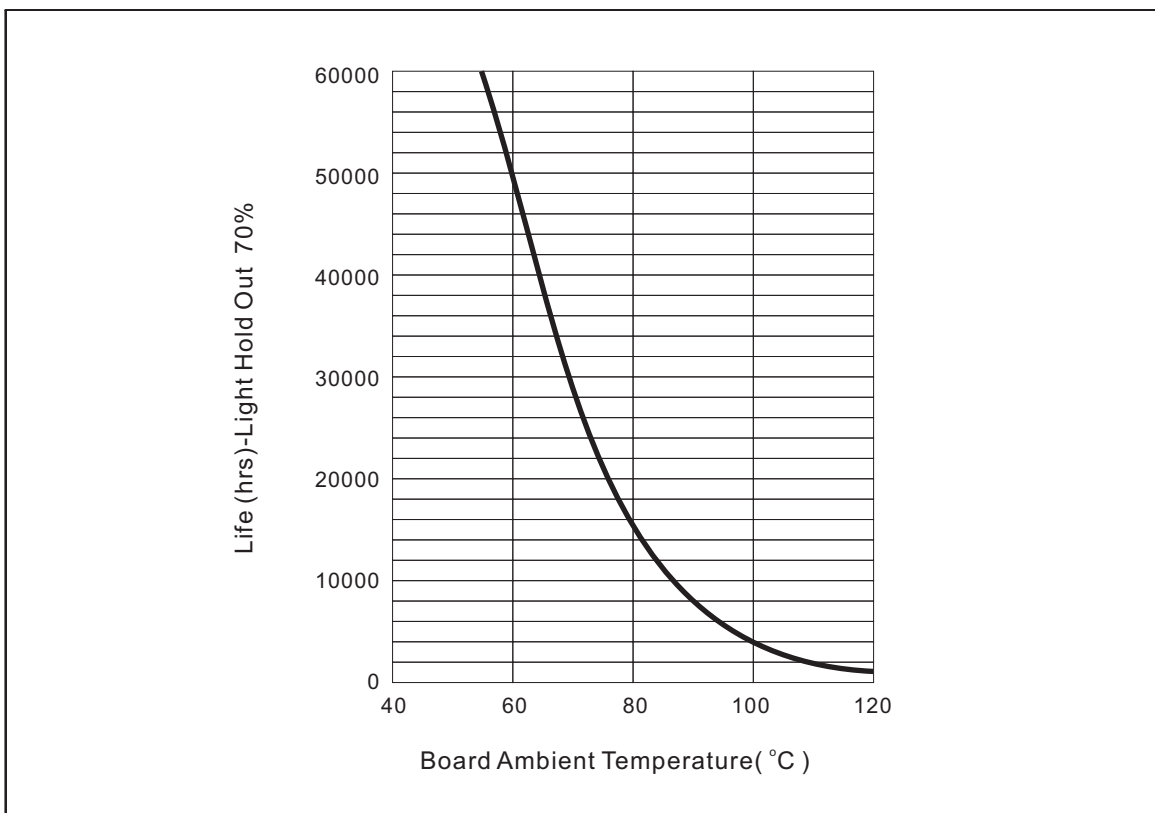
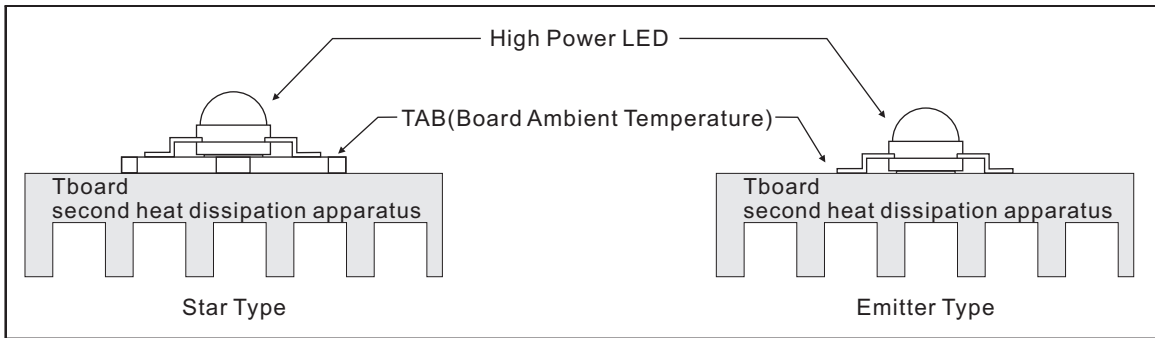

*Board Ambient Temperature Tolerance 5°C.

*TAB in this table is according to highest operating temperature 65°C.

*The TAB is the stable testing value for the product lighted 100% after one hour.

*Different materials of second heat dissipation device, the surface area of heat sink will be different. Thus, this document is for reference only.



HUEY JANN ELECTRONICS INDUSTRY CO., LTD.

No.27 Line 466 Sec.2,Canng-nan Rd. Wu-chi Town Taichung Shien, Taiwan, R.O.C.

TEL:+886-4-26393976 FAX:+886-4-26393125

Remarks:

1. Brightness values are measured during a current pulse of typical 25 ms, the brightness tolerance is $\pm 15\%$.
2. Chromaticity coordinates are measured during a current pulse of typical 200 ms, the chromaticity tolerance is ± 0.015 .
3. Forward voltage are measured during a current pulse of typical 5 ms, the VF tolerance is $\pm 0.15V$.
4. Dimensions are specified as follows: mm.
5. Related technical parameters of LED are average value resulted from statistic. The actual parameters of LED could be slightly different from average and characteristic curve.
6. The average value of LED will be changed by technical improvement and elevation, and subject to change without prior notice.
7. Hi-Power LED can not be operated without second heat dissipating structure.
8. Poor or damaged second heat dissipating structure could lead to defective electrical characteristic of High Power LED, CCT escalation, brightness drop, lifetime shortening or burn out. Following instructions of Huey Jann Hi-Power LED series document can avoid LED burn out and electrical defectiveness due to improper usage, and maintain normal performance of the products.



HUEY JANN ELECTRONICS INDUSTRY CO., LTD.

No.27 Line 466 Sec.2,Cannng-nan Rd. Wu-chi Town Taichung Shien, Taiwan, R.O.C.

TEL:+886-4-26393976 FAX:+886-4-26393125