

3W HI-POWER LED SPECIFICATION

HPR8C-4xK3x



Drawn by	Checked by	Approved by

RoHS
Conformity

DATE:2011/8/4

REV:E



HUEY JANN ELECTRONICS INDUSTRY CO., LTD.

No.27 Line 466 Sec.2,Cannng-nan Rd. Wu-chi Town Taichung Shien, Taiwan, R.O.C.

TEL:+886-4-26393976 FAX:+886-4-26393125

HUEY JANN High Power 3W LED is made of hi-eff AS/TS GaInN chips with precise package technique which makes excellent heat dissipation to reach the advantages of high luminous efficiency, low decay, and long endurance. Now we have these colors available: red, green, blue, white, yellow and infrared.

☰ **FEATERUS**

- Instant light
- Long operating life
- Superior ESD defense
- Low voltage DC operated
- More energy efficient than incandescent and most halogen lamps

☰ **TYPICAL APPLICATIONS**

- Architectural detail lighting
- Portable flashlight
- Medical applications
- Beacon lights
- Decoration lights
- Spotlight



HUEY JANN ELECTRONICS INDUSTRY CO., LTD.

No.27 Line 466 Sec.2,Canng-nan Rd. Wu-chi Town Taichung Shien, Taiwan, R.O.C.

TEL:+886-4-26393976 FAX:+886-4-26393125

Explanation of Part Number:

H P R 8 C - 4 xK 3 x / WPCB
① ② ③ ④ ⑤ ⑥ ⑦ ⑧ ⑨ ⑩

1.H: Huey Jann

2.P: High power LED Type

3.Shape distinguish:

B: Lambertian type S: Side emitting type
D: Focusing type E: Focusing type
R: Reflector type

4.Identification no:

5.Lead frame type

6.Appearance:

1:White Diffusion
4:Water Clear

7.Color number:

3K: Green 4K: Yellow
5K: Red 8K: Blue
9K: White

8.Power type:

Non: 1W 05: 0.5W
3: 3W 5: 5W

9.Color kind:

G: Green Y: Yellow
R: Red BG: Blue

10.Heat conduction type:

Non: emitter type
/WPCB: with white star type heat sink



HUEY JANN ELECTRONICS INDUSTRY CO., LTD.

No.27 Line 466 Sec.2,Cannng-nan Rd. Wu-chi Town Taichung Shien, Taiwan, R.O.C.

TEL:+886-4-26393976 FAX:+886-4-26393125

DEVICES

Emitter Type

Item	Lens Color	Dice Source	Color
HPR8C-43K3G	White Diffused	GaN/GaN	Green
HPR8C-44K3Y		AlInGaP/GaP	Yellow
HPR8C-45K3R		AlInGaP/GaP	Red
HPR8C-48K3BG		GaN/GaN	Blue

With White Star MCPCB Type

Item	Lens Color	Dice Source	Color
HPR8C-43K3G/WPCB	White Diffused	GaN/GaN	Green
HPR8C-44K3Y/WPCB		AlInGaP/GaP	Yellow
HPR8C-45K3R/WPCB		AlInGaP/GaP	Red
HPR8C-48K3BG/WPCB		GaN/GaN	Blue



HUEY JANN ELECTRONICS INDUSTRY CO., LTD.

No.27 Line 466 Sec.2,Cannng-nan Rd. Wu-chi Town Taichung Shien, Taiwan, R.O.C.

TEL:+886-4-26393976 FAX:+886-4-26393125

PACKAGE DIMENSIONS:

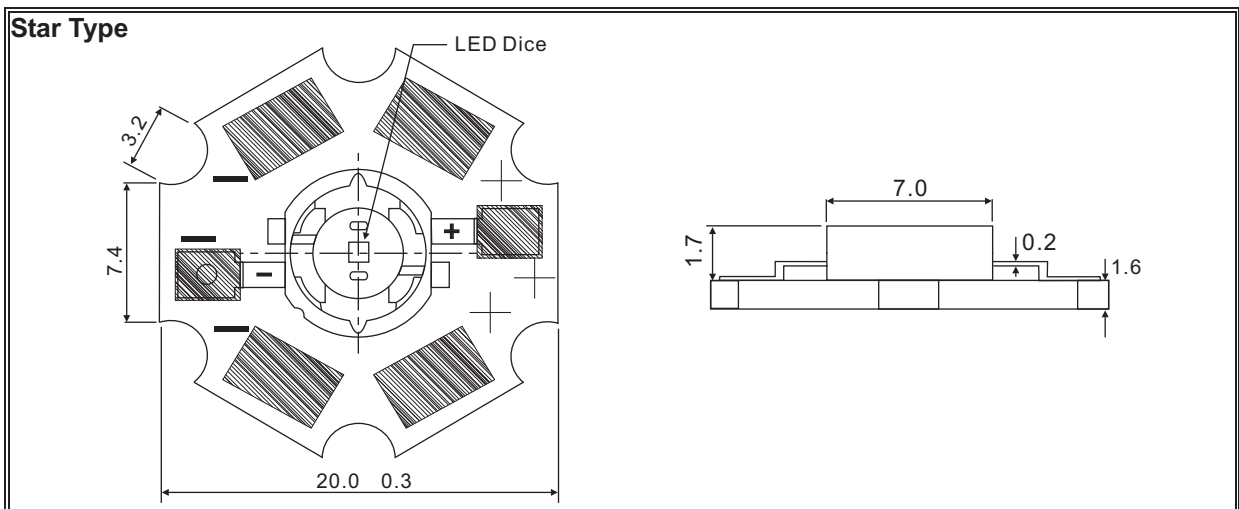
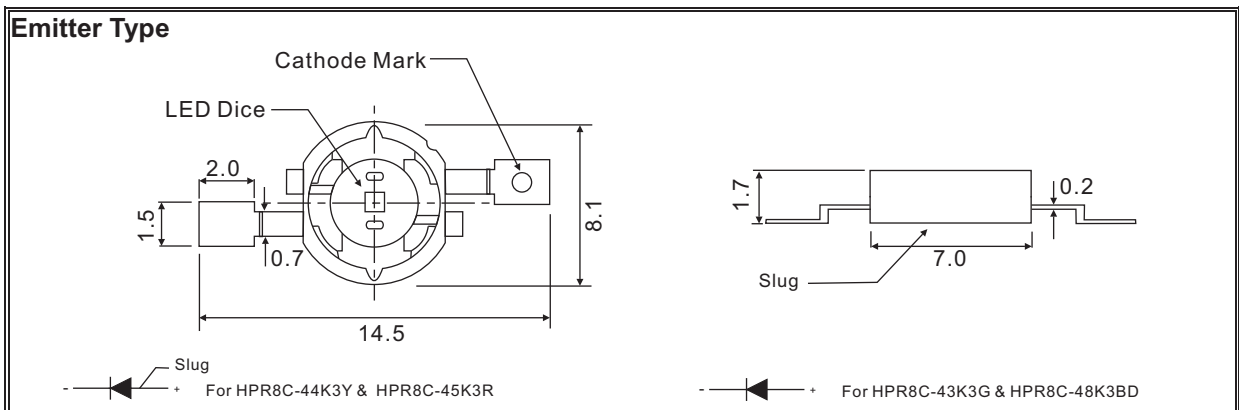

NOTE:

- 1.All dimensions are in millimeter.
- 2.Lead spacing in measured where the lead emerge from the package.
- 3.prodruded resin under flange is 1.5mm max.
- 4.specifications are subject to change without notice.
- 5.Tolerance is 0.3mm unless otherwise noted.
- 6.Driving LED without heat sinking device is forbidden.
- 7.It is strongly recommended that the temperature of lead be not higher than 55°C.
- 8.Proper current derating must be observed to maintain junction temperature below the maximum.
- 9.LEDs are not designed to be driven in reserve bias.



HUEY JANN ELECTRONICS INDUSTRY CO., LTD.

No.27 Line 466 Sec.2,Cannng-nan Rd. Wu-chi Town Taichung Shien, Taiwan, R.O.C.

TEL:+886-4-26393976 FAX:+886-4-26393125

ABSOLUTE MAXIMUM RATINGS

TA=25°C

PARAMETER	SYMBOL	MAX. RATING		UNIT
Continuous Forward Current	IF	700		mA
Peak Forward Current *1	IFM	1000		mA
Electrostatic Discharge(HBM)	ESD	4000		V
LED Junction Temperature	Tj	G · B	135	°C
		R · Y	125	
Operating Temperature	Topr	-40 ~ +110		°C
Storage Temperature	Tstg	-40 ~ +120		°C
Manual Soldering Temperature 260 °C for 5 seconds max. *2 *3				

*1.Duty Ratio=0.1%,Pulse Width=10us.

*2.Iron soldering high temperature will not cause damage to the dice. But be aware of the high temperature will not only make the epoxy soften but also cause the lead moving and the gold wire broken and even open. So before returning to the normal temperatures PLEASE AVOID any serious pressure on the top of epoxy and lead.

*3.Measured at leads, lens temperature must not exceed 120°C during lead soldering and slug attach. Soldering by general IR reflow, Vapor phase reflow and wave soldering on this system product is unsuitable. Selective heating of the leads limit lead soldering, such as by hot bar reflow, fiber focussed IR, or hand soldering. The package back plane (slug) may not be attached by soldering, but rather with a thermally conductive adhesive. Electrical insulation between the slug and the board is necessary. Please consult welding matters needing attention.



HUEY JANN ELECTRONICS INDUSTRY CO., LTD.

No.27 Line 466 Sec.2,Cannng-nan Rd. Wu-chi Town Taichung Shien, Taiwan, R.O.C.

TEL:+886-4-26393976 FAX:+886-4-26393125

ELECTRIC-OPTICAL CHARACTERISTICS

TA=25°C

PARAMETER	SYMBOL	TEST CONDITION	TYP	MAX	UNIT
View Angle of Half Power	2θ _{1/2}	IF=700mA	110		deg
Thermal Resistance Junction To Case	R _{θ J-C}		13		°C/W
Thermal Resistance Junction To Case With Star Type Heat Sink	R _{θ J-C}		17		°C/W
Temperature Coefficient Of Forward Voltage	ΔV _F /ΔT		-2		mV/°C

ELECTRIC-OPTICAL CHARACTERISTICS FOR FORWARD VOLTAGE

TA=25°C

Item	Symbol	Test Condition	Typ	Max	Unit
HPR8C-43K3Gx	Green	IF=700mA	3.6	4.2	V
HPR8C-44K3Yx	Yellow		2.3	2.8	
HPR8C-45K3Rx	Red		2.3	2.8	
HPR8C-48K3BGx	Blue		3.8	4.2	



HUEY JANN ELECTRONICS INDUSTRY CO., LTD.

No.27 Line 466 Sec.2,Cannng-nan Rd. Wu-chi Town Taichung Shien, Taiwan, R.O.C.

TEL:+886-4-26393976 FAX:+886-4-26393125

ELECTRIC-OPTICAL CHARACTERISTICS FOR LUMINOUS INTENSITY

Item	Symbol	Test Condition	Min	Typ	Unit
HPR8C-43K3Gx	Green	IV IF=700mA		100	lm
HPR8C-44K3Yx	Yellow			75	
HPR8C-45K3Rx	Red			85	
HPR8C-48K3BGx	Blue			52	

ELECTRIC-OPTICAL CHARACTERISTICS FOR WAVELENGTH

Item	Test Condition	λ_p	λ_d	Unit
HPR8C-43K3Gx	IF=700mA	520	525	nm
HPR8C-44K3Yx		595	590	
HPR8C-45K3Rx		635	625	
HPR8C-48K3BGx		462	465	



HUEY JANN ELECTRONICS INDUSTRY CO., LTD.

No.27 Line 466 Sec.2,Cannng-nan Rd. Wu-chi Town Taichung Shien, Taiwan, R.O.C.

TEL:+886-4-26393976 FAX:+886-4-26393125

RELIABILITY TEST

Endurance Test

Test Item	Reference Standard	Test Conditions	Result
Operation Life	MIL-STD-750:1026 MIL-STD-883:1005 JIS-C-7021 :B-1	Connect with a power if=700mA Ta=Under room temperature Test Time=1,000hrs	0/22
High Temperature High Humidity Storage	MIL-STD-202:103B JIS-C-7021 :B-11	Ta=+85°C 5°C RH=80% ~ 85% Test Time=1,000hrs	0/22
High Temperature Storage	MIL-STD-883:1008 JIS-C-7021 :B-10	High Ta=+120°C 5°C Test Time=1,000hrs	0/22
Low Temperature Storage	JIS-C-7021 :B-12	Low Ta=-40°C 5°C Test Time=1,000hrs	0/22

*Failure Criteria:

1. VF arise $\geq 10\%$
2. IV decline $\geq 30\%$
3. A failure is an LED that is open or shorted



HUEY JANN ELECTRONICS INDUSTRY CO., LTD.

No.27 Line 466 Sec.2,Cannng-nan Rd. Wu-chi Town Taichung Shien, Taiwan, R.O.C.

TEL:+886-4-26393976 FAX:+886-4-26393125

RELIABILITY TEST

➤ Environmental Test

Test Item	Reference Standard	Test Conditions	Result
Temperature Cycling	MIL-STD-202:107D MIL-STD-750:1051 MIL-STD-883:1010 JIS-C-7021 :A-4	-40°C ~ +25°C ~ +85°C ~ +25°C 60min 20min 60min 20min Test Time=200cycle	0/22
Thermal Shock	MIL-STD-202:107D MIL-STD-750:1051 MIL-STD-883:1010	-40°C 5°C ~ +110°C 5°C 20min 20min Test Time=200cycle	0/22

*Failure Criteria:

1. VF arise $\geq 10\%$
2. IV decline $\geq 30\%$
3. A failure is an LED that is open or shorted



HUEY JANN ELECTRONICS INDUSTRY CO., LTD.

No.27 Line 466 Sec.2,Canng-nan Rd. Wu-chi Town Taichung Shien, Taiwan, R.O.C.

TEL:+886-4-26393976 FAX:+886-4-26393125

TYPICAL ELECTRICAL OPTICAL CHARACTERISTICS CURVES

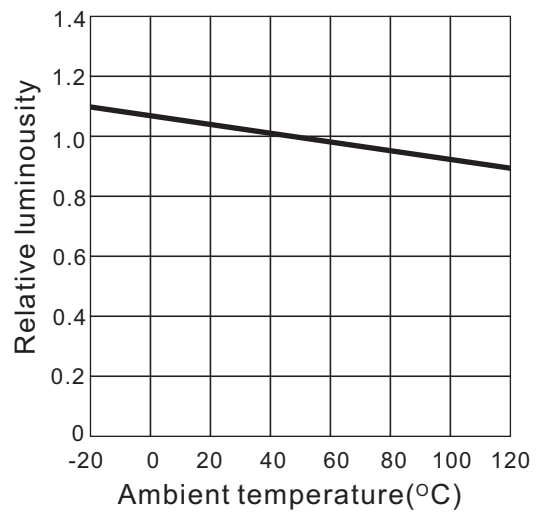
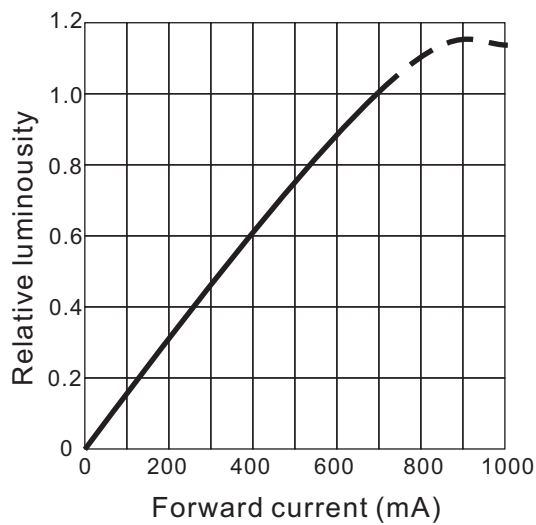
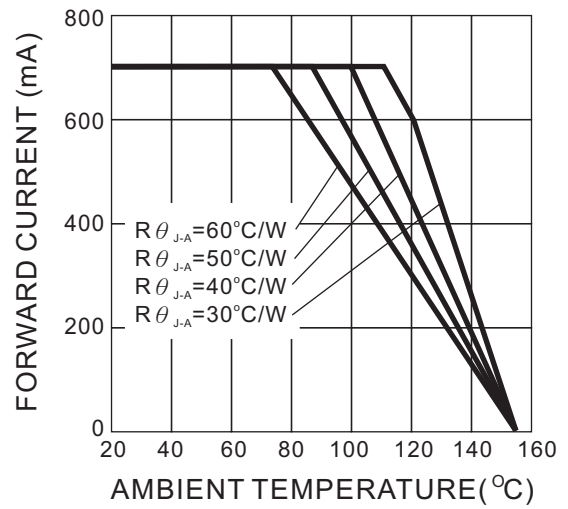
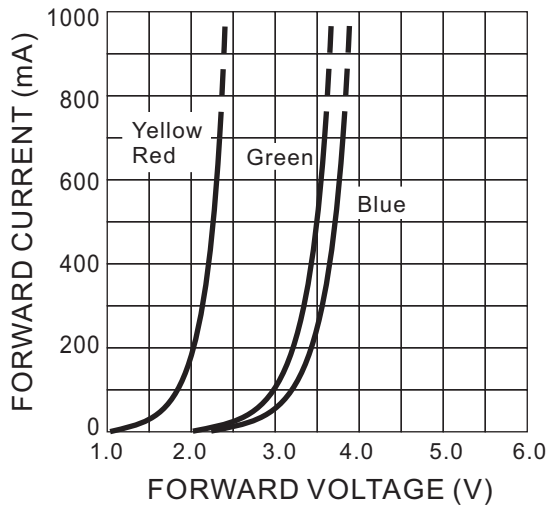

HUEY JANN ELECTRONICS INDUSTRY CO., LTD.

No.27 Line 466 Sec.2,Cannng-nan Rd. Wu-chi Town Taichung Shien, Taiwan, R.O.C.

TEL:+886-4-26393976 FAX:+886-4-26393125

TYPICAL ELECTRICAL OPTICAL CHARACTERISTICS CURVES

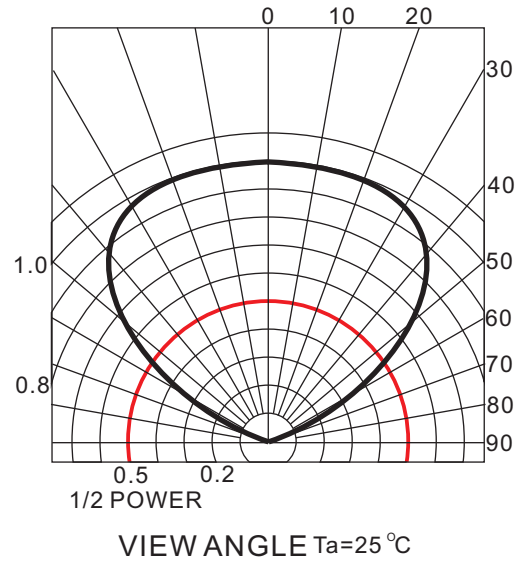
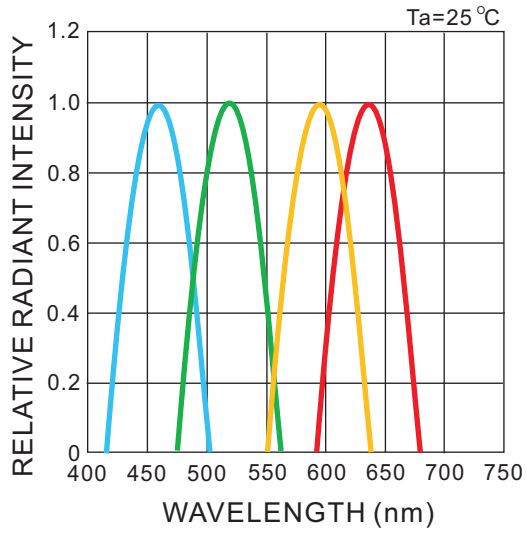

HUEY JANN ELECTRONICS INDUSTRY CO., LTD.

No.27 Line 466 Sec.2, Canng-nan Rd. Wu-chi Town Taichung Shien, Taiwan, R.O.C.

TEL:+886-4-26393976 FAX:+886-4-26393125

Brightness Bin Selection

3W Green Color

Brightness Code		
BIN CODE	Brightness in lm	
	Minimum	Maximum
L	85	110

3W Yellow Color

Brightness Code		
BIN CODE	Brightness in lm	
	Minimum	Maximum
K	65	85

3W Red Color

Brightness Code		
BIN CODE	Brightness in lm	
	Minimum	Maximum
K	65	85
L	85	110

3W Blue Color

Brightness Code		
BIN CODE	Brightness in lm	
	Minimum	Maximum
H	38	50
J	50	65

NOTE:

1. Test Condition at IF=700mA.



HUEY JANN ELECTRONICS INDUSTRY CO., LTD.

No.27 Line 466 Sec.2,Canng-nan Rd. Wu-chi Town Taichung Shien, Taiwan, R.O.C.

TEL:+886-4-26393976 FAX:+886-4-26393125

Package Dimension For Emitter Type

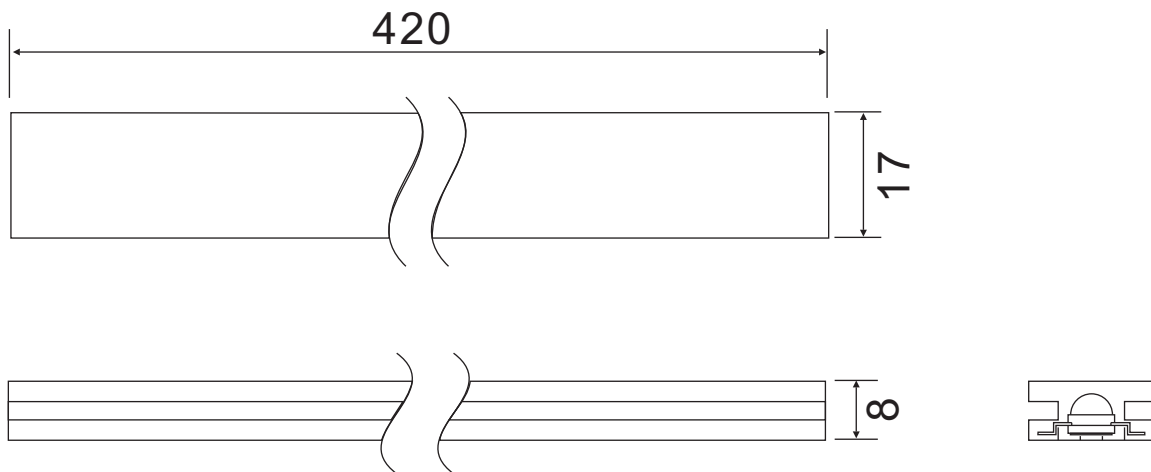

NOTE:

1. Dimensions are specified as follows: mm.
2. Tolerance is 0.3mm unless otherwise noted.
3. 50 pcs emitters per tube.
4. 80 tubes per inside box.
5. 4 inside box per outside box.



HUEY JANN ELECTRONICS INDUSTRY CO., LTD.

No.27 Line 466 Sec.2,Canng-nan Rd. Wu-chi Town Taichung Shien, Taiwan, R.O.C.

TEL:+886-4-26393976 FAX:+886-4-26393125

Package Dimension For Star Type

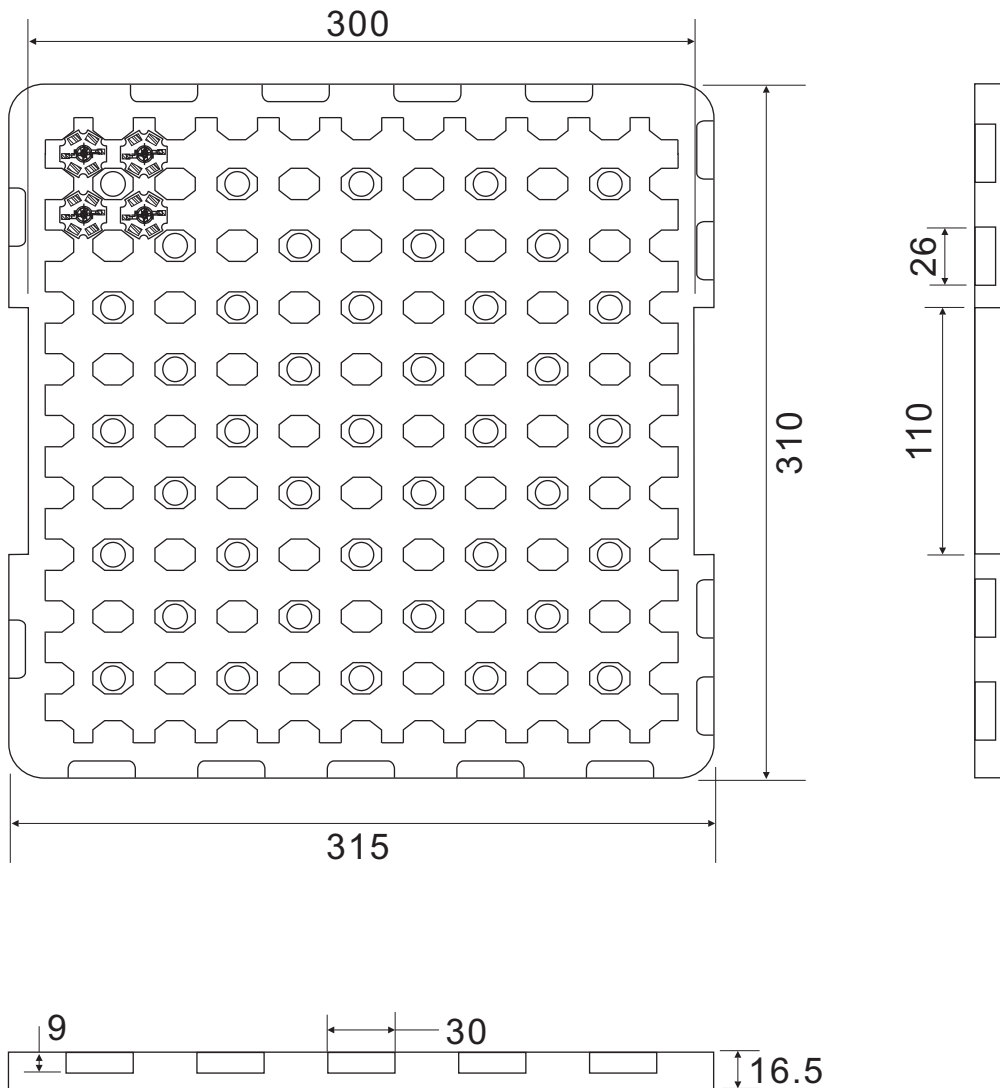

NOTE:

1. Dimensions are specified as follows: mm.
2. Tolerance is 0.3mm unless otherwise noted.
3. 100pcs star per tray.
4. 10 trays per box.



HUEY JANN ELECTRONICS INDUSTRY CO., LTD.

No.27 Line 466 Sec.2,Canng-nan Rd. Wu-chi Town Taichung Shien, Taiwan, R.O.C.

TEL:+886-4-26393976 FAX:+886-4-26393125

Requirements to user For Emitter Type

The LED products by HUEY-JANN is designed, manufactured, and sold aiming at high standard quality and reliability, however, reliability of electronic apparatus is seen as a product of reliability superior to HUEY-JANN and using status at users. From this point, HUEY-JANN requests user's for following things.

Please do not extrude the colloid

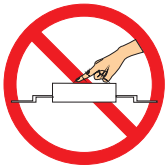

Recommended Solder Pad Design For Emitter Type

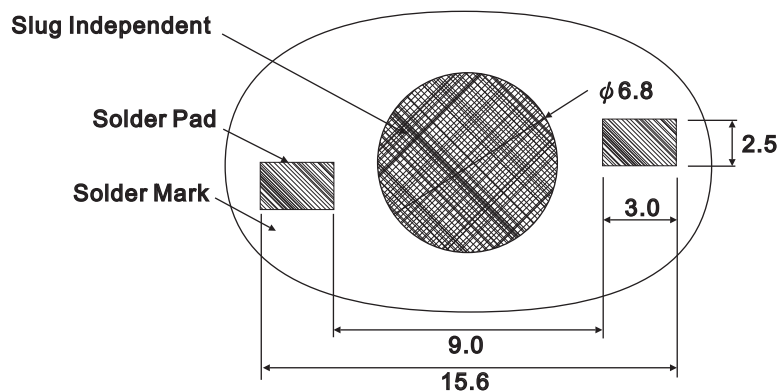

Note:

- 1.All dimensions are in millimeters.
- 2.Electrical isolation is required between Slug and Solder Pad.



HUEY JANN ELECTRONICS INDUSTRY CO., LTD.

No.27 Line 466 Sec.2,Cannng-nan Rd. Wu-chi Town Taichung Shien, Taiwan, R.O.C.

TEL:+886-4-26393976 FAX:+886-4-26393125

Heat Plate Soldering Condition For Emitter Type

a. Soldering Process for Solder Paste

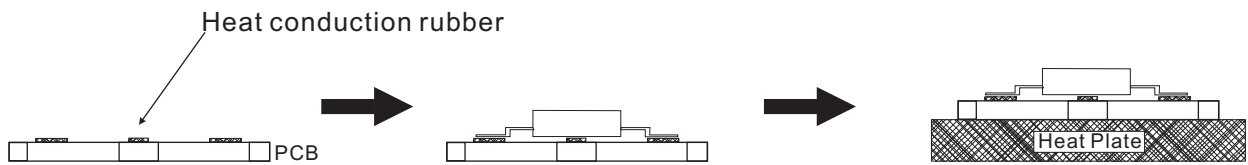

Use Solder Mask to print Solder Paste on PCB.

Place Emitter on PCB.

Put PCB on Heat Plate until Solder Paste melt.

- 1.The Solder Paste could be melted within 10 seconds.
- 2.Take out PCB out from Heat Plate within 15 seconds.

b. Soldering Process for Solder Wire

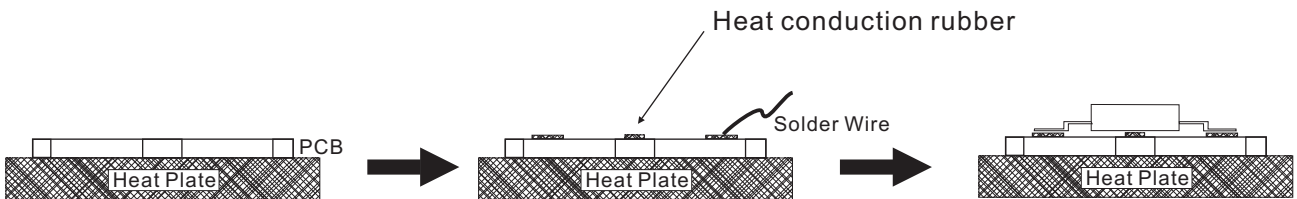

Put PCB on Heat Plate.

Place Solder Wire to the solder pad of PCB.

Put Emitter on PCB. Take the PCB out from Heat Plate within 10 seconds.

NOTE:

- 1.Heat plate temperature: 230°C max for Lead Solder and 260 °C max for Lead-Free Solder.
- 2.When soldering, do not put stress on the LEDs during heating.
- 3.After soldering, do not warp the circuit board.



HUEY JANN ELECTRONICS INDUSTRY CO., LTD.

No.27 Line 466 Sec.2,Cannng-nan Rd. Wu-chi Town Taichung Shien, Taiwan, R.O.C.

TEL:+886-4-26393976 FAX:+886-4-26393125

Soldering Process For Hot Bar For Emitter Type

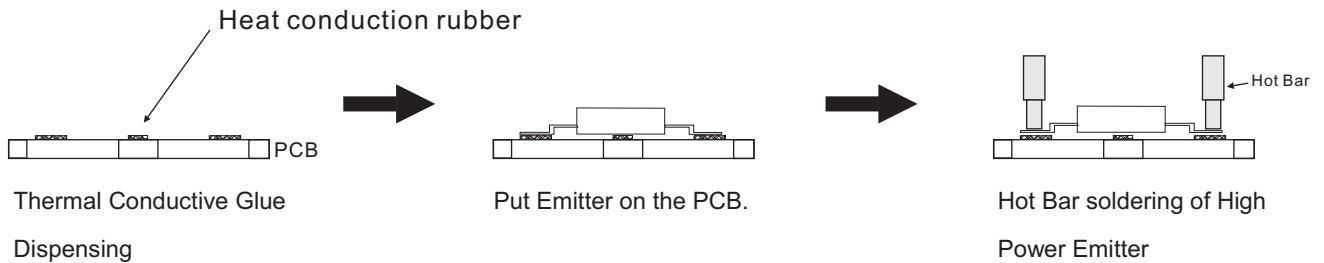

NOTE:

- 1.Hot Bar temperature: 230°C max for Lead Solder and 260°C max for Lead-Free Solder.
- 2.When soldering, do not put stress on the LEDs during heating.
- 3.After soldering, do not warp the circuit board.

Manual Hand Soldering For Emitter Type

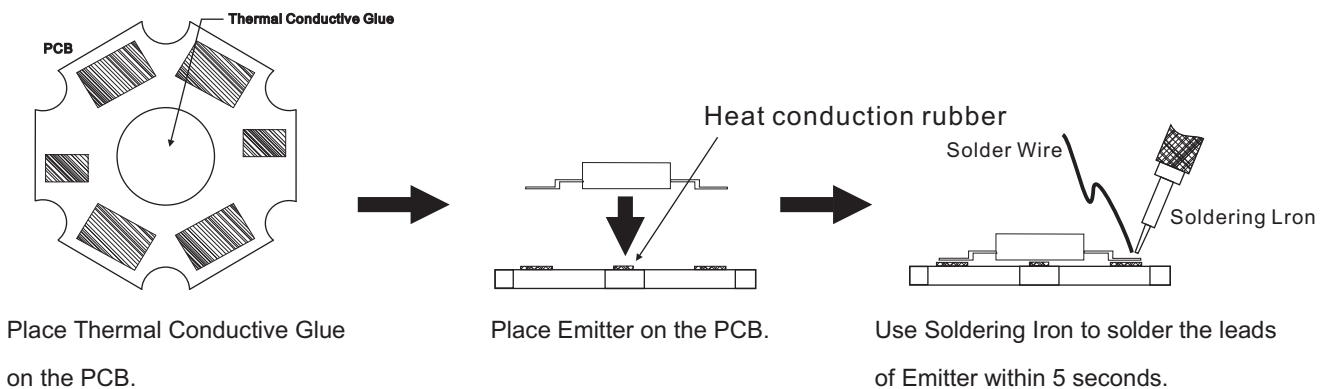

- 1.Solder tip temperature: 230°C max for Lead Solder and 260°C max for Lead-Free Solder.
- 2.Avoiding damage to the emitter or to the PCB dielectric layer. Damage to the epoxy layer can cause
- 3.Do not let the solder contact from solder pad to back-side of PCB. This one will cause a short circuit and damage emitter.



HUEY JANN ELECTRONICS INDUSTRY CO., LTD.

No.27 Line 466 Sec.2,Cannng-nan Rd. Wu-chi Town Taichung Shien, Taiwan, R.O.C.

TEL:+886-4-26393976 FAX:+886-4-26393125

Reflow Solder Condition For Emitter Type

Profile Feature	Sn-Pb Eutectic Assembly	Lead-Free Assembly
Average Ramp-Up Rate (T_{max} To T_p)	3 °C/sec max	3 °C/sec max
Average Ramp-Down Rate	6 °C/sec max	6 °C/sec max
Preheat Temperature Min Temperature Max Time	100 °C 150 °C 60-120sec	150 °C 200 °C 60-180sec
Time Maintained Above Temperature (T_L) Time Max	180 °C 150sec	210 °C 150sec
Peak Temperature (T_p)	240 °C	260 °C
Time Within 5°C of Actual Peak Temperature (t_p)	10 ~ 30sec	20 ~ 40sec

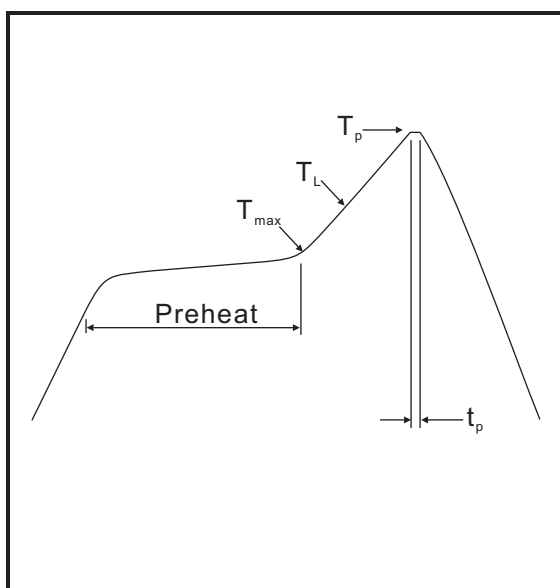

Note:

- 1.All temperature regarding topside of the package, measured on the package body surface.
- 2.After the LEDs have been soldered repairing should not be done. When repairing is unavoidable, a heat plate should be used. It should be confirmed beforehand whether the characteristics of LEDs will or will not be damaged by repairing.
- 3.Reflow soldering more than two times is not recommended.
- 4.While soldering do not put stress on the LEDs during heating.
- 5.After soldering do not warp the circuit board.





HUEY JANN ELECTRONICS INDUSTRY CO., LTD.

No.27 Line 466 Sec.2,Cann-g-nan Rd. Wu-chi Town Taichung Shien, Taiwan, R.O.C.

TEL:+886-4-26393976 FAX:+886-4-26393125

Conclusion

Huey Jann provide simple comparison table for High Power LED, you could find your request heat dissipation area from the following table.

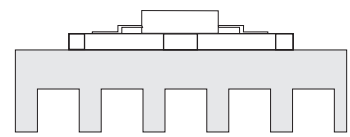
	 Free Convection Horizontal Flat Heat Dissipation-Set-up (Area Require mm ²)	 Free Convection Vertical Flat Heat Dissipation-Set-up (Area Require mm ²)	 Free Convection Finned Heat Dissipation-Set-up (Area Require mm ²)
Green	6,600	5,400	8,700
Yellow	3,300	2,700	4,500
Red	2,100	1,800	2,700
Blue	5,400	4,500	7,200

*TAB in this table is according to highest operating temperature 65°C.

*Different materials of second heat dissipation device, the surface area of heat sink will be different. Thus, this document is for reference only.



HUEY JANN ELECTRONICS INDUSTRY CO., LTD.

No.27 Line 466 Sec.2,Cannng-nan Rd. Wu-chi Town Taichung Shien, Taiwan, R.O.C.

TEL:+886-4-26393976 FAX:+886-4-26393125

TAB Temperature - Life Characteristics Curves

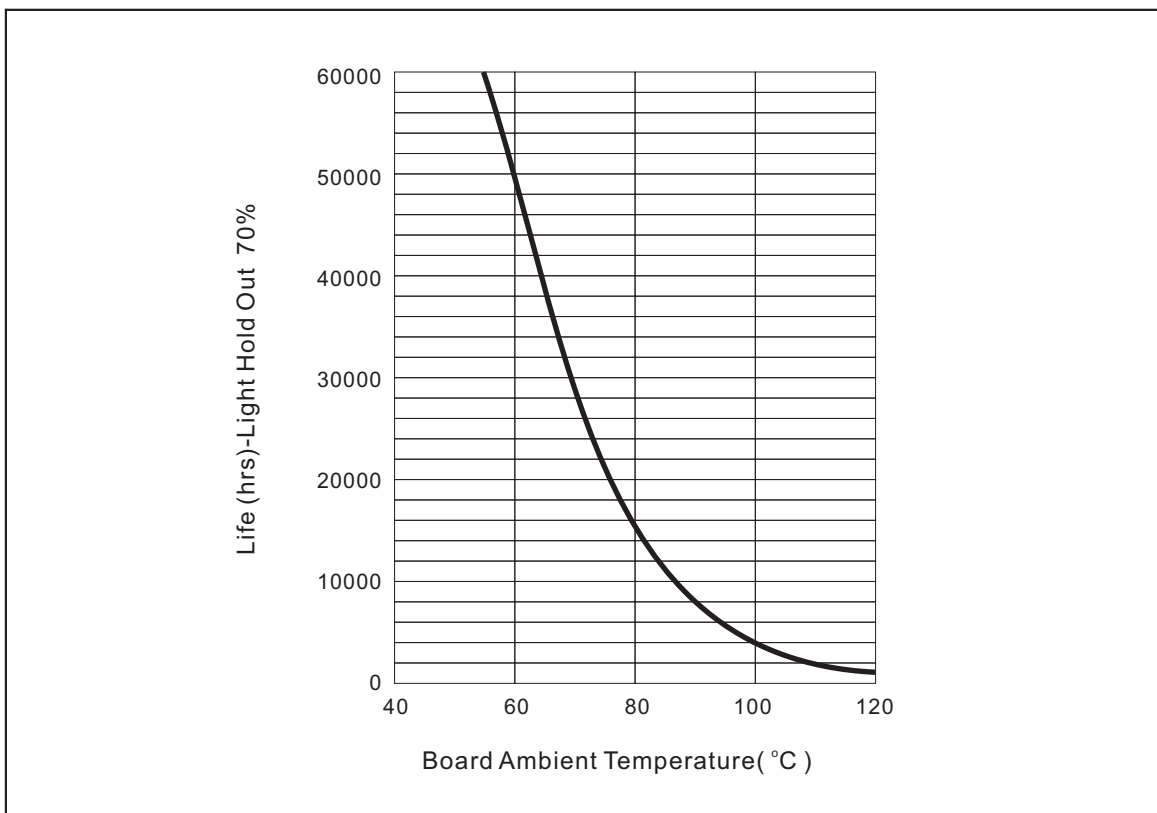
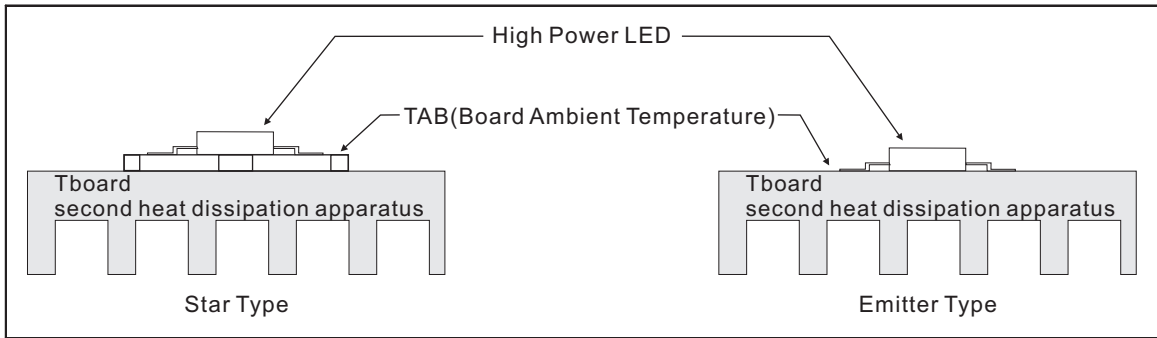

*Board Ambient Temperature Tolerance 5°C.

*TAB in this table is according to highest operating temperature 65°C.

*The TAB is the stable testing value for the product lighted 100% after one hour.

*Different materials of second heat dissipation device, the surface area of heat sink will be different. Thus, this document is for reference only.



HUEY JANN ELECTRONICS INDUSTRY CO., LTD.

No.27 Line 466 Sec.2,Cannng-nan Rd. Wu-chi Town Taichung Shien, Taiwan, R.O.C.

TEL:+886-4-26393976 FAX:+886-4-26393125

Remarks:

1. Brightness values are measured during a current pulse of typical 25 ms, the brightness tolerance is $\pm 15\%$.
2. Dominant wavelength are measured during a current pulse of typical 200 ms, the chromaticity tolerance is $\pm 1.0\text{nm}$.
3. Forward voltage are measured during a current pulse of typical 5 ms, the VF tolerance is $\pm 0.15\text{V}$.
4. Dimensions are specified as follows: mm.
5. Related technical parameters of LED are average value resulted from statistic. The actual parameters of LED could be slightly different from average and characteristic curve.
6. The average value of LED will be changed by technical improvement and elevation, and subject to change without prior notice.
7. Hi-Power LED can not be operated without second heat dissipating structure.
8. Poor or damaged second heat dissipating structure could lead to defective electrical characteristic of High Power LED, CCT escalation, brightness drop, lifetime shortening or burn out. Following instructions of Huey Jann Hi-Power LED series document can avoid LED burn out and electrical defectiveness due to improper usage, and maintain normal performance of the products.



HUEY JANN ELECTRONICS INDUSTRY CO., LTD.

No.27 Line 466 Sec.2, Cannng-nan Rd. Wu-chi Town Taichung Shien, Taiwan, R.O.C.

TEL:+886-4-26393976 FAX:+886-4-26393125