

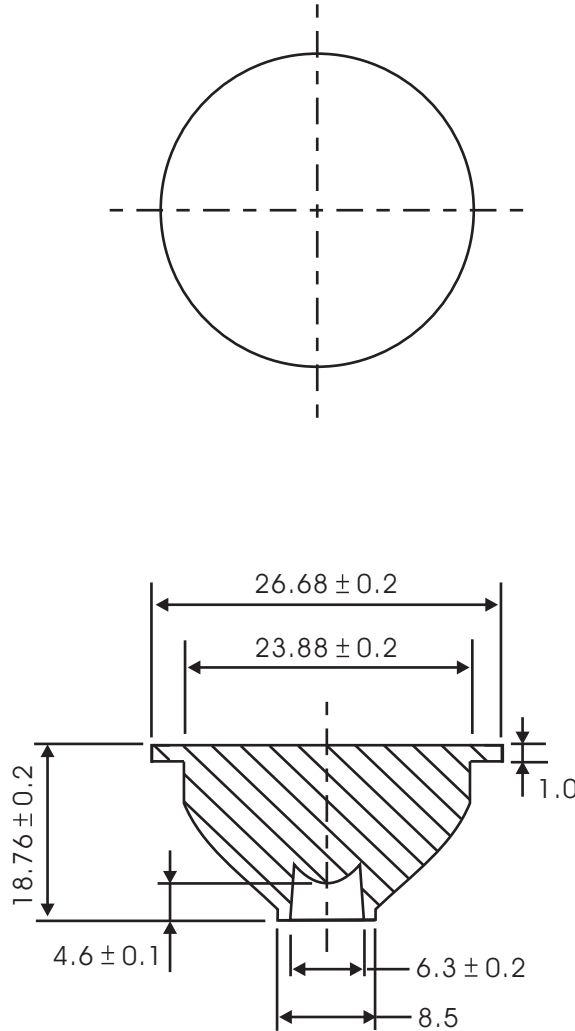

HOLDER PRODUCTS

PACKAGE DIMENSIONS:



View Angle $2\theta 1/2: 8^\circ$

NOTE:

- 1.All dimensions are in millimeter.
- 2.specifications are subject to change without notice.
- 3.Tolerance is 0.5mm unless otherwise noted.

HUEY JANN ELECTRONICS INDUSTRY CO., LTD.

DEVICE NO: HPH3

DWG NO:

REV: B

DATE:2009/1/15

DWN: C.Y.Lin

CHK: Dundee

This drawing contains proprietary information and is not to be used or reproduced without permission of HUEY-JANN.

HUEY JANN ELECTRONICS INDUSTRY CO., LTD.