

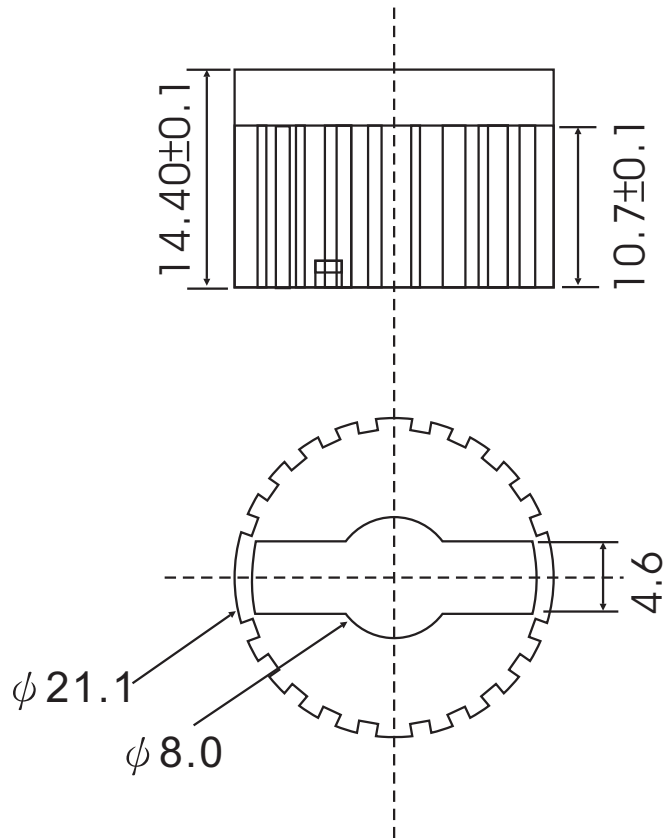

# HOLDER PRODUCTS

## PACKAGE DIMENSIONS:



View Angle  $2\theta 1/2: 25^\circ$

### NOTE:

1. All dimensions are in millimeter.
2. specifications are subject to change without notice.
3. Tolerance is 0.5mm unless otherwise noted.

HUEY JANN ELECTRONICS INDUSTRY CO., LTD.

DEVICE NO: HPH8

DWG NO:

REV: A

DATE: 2008/10/16

DWN: C.Y.Lin

CHK: Dundee

This drawing contains proprietary information and is not to be used or reproduced without permission of HUEY-JANN.

HUEY JANN ELECTRONICS INDUSTRY CO., LTD.