

HI-POWER INFRARED LED SPECIFICATION

HIRPD8-1Gx



Drawn by	Checked by	Approved by



DATE:2010/6/14

REV:B

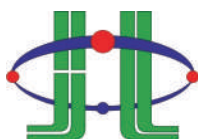

HUEY JANN ELECTRONICS INDUSTRY CO., LTD.

No.27 Line 466 Sec.2,Cannng-nan Rd. Wu-chi Town Taichung Shien, Taiwan, R.O.C.

TEL:+886-4-26393976 FAX:+886-4-26393125

HUEY JANN Infrared High Power LED is made of hi-eff GaAlAs chips with precise package technique which makes excellent heat dissipation to reach the advantages of high radiant output power efficiency, low decay, and long endurance.

☰ **FEATERUS**

- Instant light
- Long operating life
- Superior ESD defense
- Low voltage DC operated
- More energy efficient than incandescent and most halogen lamps

☰ **TYPICAL APPLICATIONS**

- Remote controller
- Monitor illumination
- Security system
- Fire control
- 3C products
- Data-transmission
- Special medical

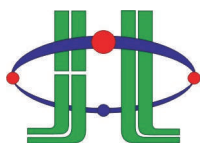

HUEY JANN ELECTRONICS INDUSTRY CO., LTD.

No.27 Line 466 Sec.2,Cannng-nan Rd. Wu-chi Town Taichung Shien, Taiwan, R.O.C.

TEL:+886-4-26393976 FAX:+886-4-26393125

☰ Explanation of Part Number:

H IR P D 8 - 1 Gx / WPCB
① ② ③ ④ ⑤ ⑥ ⑦ ⑧

1. H: Huey Jann

2. IR: Infrared LED Type

3. P: High power LED Type

4. Shape distinguish:

B: Lambertian type S: Side emitting type

D: Focusing type E: Focusing type

R: Reflector type

5. Identification no:

6. Appearance:

1:White Diffusion 4:Water Clear

7. Dice kind:

G: 850nm For 1000mA

Gb: 850nm For 500mA

8. Heat conduction type:

Non: emitter type

/WPCB: with white star type heat sink

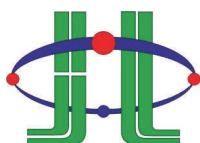

HUEY JANN ELECTRONICS INDUSTRY CO., LTD.

No.27 Line 466 Sec.2,Cannng-nan Rd. Wu-chi Town Taichung Shien, Taiwan, R.O.C.

TEL:+886-4-26393976 FAX:+886-4-26393125

☰ DEVICES

Emitter Type

Item	Lens Color	Dice Source	Color
HIRPD8-1G	Water Clear	GaAIAs/GaAIAs	Infrared
HIRPD8-1Gb		GaAIAs/GaAIAs	Infrared

With White Star MCPCB Type

Item	Lens Color	Dice Source	Color
HIRPD8-1G/WPCB	Water Clear	GaAIAs/GaAIAs	Infrared
HIRPD8-1Gb/WPCB		GaAIAs/GaAIAs	Infrared

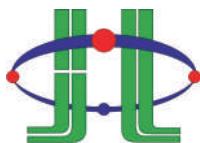

HUEY JANN ELECTRONICS INDUSTRY CO., LTD.

No.27 Line 466 Sec.2,Cannng-nan Rd. Wu-chi Town Taichung Shien, Taiwan, R.O.C.

TEL:+886-4-26393976 FAX:+886-4-26393125

PACKAGE DIMENSIONS:

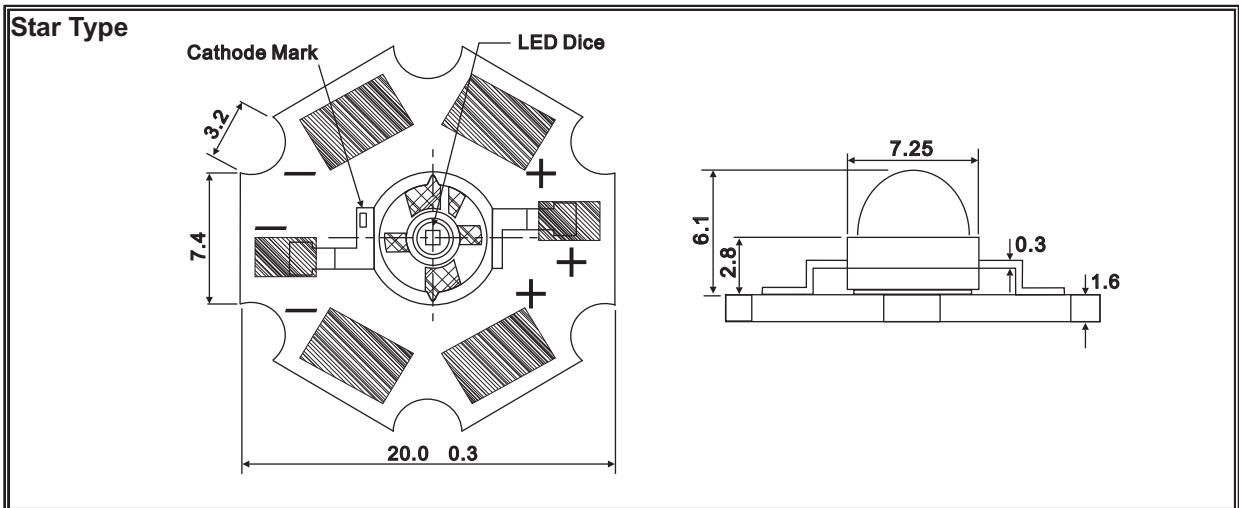
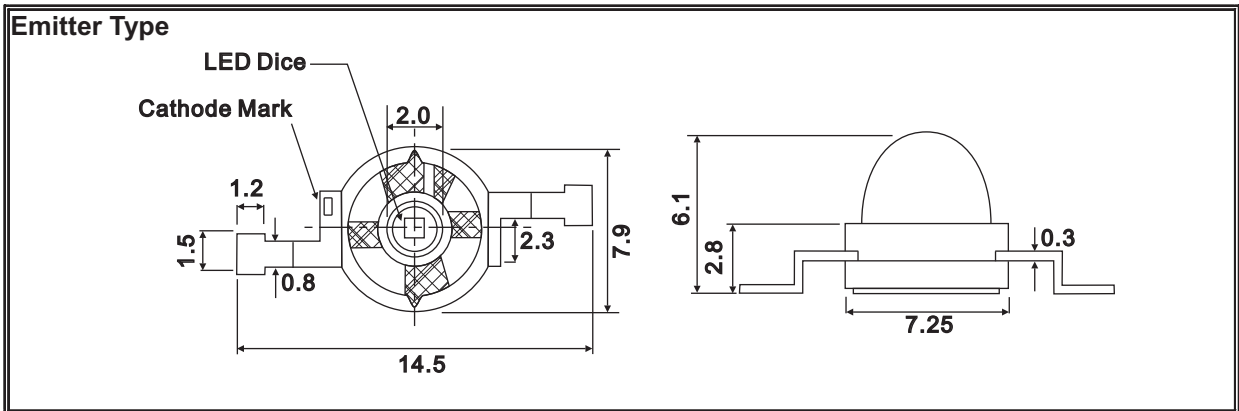

NOTE:

- 1.All dimensions are in millimeter.
- 2.Lead spacing in measured where the lead emerge from the package.
- 3.prodruded resin under flange is 1.5mm max.
- 4.specifications are subject to change without notice.
- 5.Tolerance is 0.3mm unless otherwise noted.
- 6.Driving LED without heat sinking device is forbidden.
- 7.It is strongly recommended that the temperature of lead be not higher than 55°C.
- 8.Proper current derating must be observed to maintain junction temperature below the maximum.
- 9.LEDs are not designed to be driven in reserve bias.

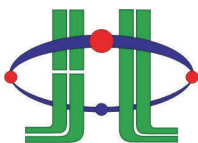

HUEY JANN ELECTRONICS INDUSTRY CO., LTD.

No.27 Line 466 Sec.2,Cannng-nan Rd. Wu-chi Town Taichung Shien, Taiwan, R.O.C.

TEL:+886-4-26393976 FAX:+886-4-26393125

ABSOLUTE MAXIMUM RATINGS

TA=25°C

PARAMETER		SYMBOL	MAX. RATING	UNIT
Continuous Forward Current	HIRPD8-1Gx	IF	1000	mA
	HIRPD8-1Gbx		500	
Peak Forward Current *1	HIRPD8-1Gx	IFM	1500	mA
	HIRPD8-1Gbx		1000	
Reverse Voltage		VR	5	V
LED Junction Temperature		Tj	120	°C
Operating Temperature		Topr	-40 ~ +110	°C
Storage Temperature		Tstg	-40 ~ +120	°C
Manual Soldering Temperature 260 °C for 5 seconds max. *2 *3				

*1.Duty Ratio=0.1%,Pulse Width=10us.

*2.Iron soldering high temperature will not cause damage to the dice. But be aware of the high temperature will not only make the epoxy soften but also cause the lead moving and the gold wire broken and even open. So before returning to the normal temperatures PLEASE AVOID any serious pressure on the top of epoxy and lead.

*3.Measured at leads, lens temperature must not exceed 120°C during lead soldering and slug attach. Soldering by general IR reflow, Vapor phase reflow and wave soldering on this system product is unsuitable. Selective heating of the leads limit lead soldering, such as by hot bar reflow, fiber focussed IR, or hand soldering. The package back plane (slug) may not be attached by soldering, but rather with a thermally conductive adhesive. Electrical insulation between the slug and the board is necessary. Please consult welding matters needing attention.

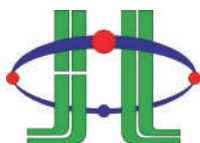

HUEY JANN ELECTRONICS INDUSTRY CO., LTD.

No.27 Line 466 Sec.2,Cannng-nan Rd. Wu-chi Town Taichung Shien, Taiwan, R.O.C.

TEL:+886-4-26393976 FAX:+886-4-26393125

ELECTRIC-OPTICAL CHARACTERISTICS FOR HIRPD8-1Gx

TA=25°C

PARAMETER	SYMBOL	TEST CONDITION	MIN	TYP	MAX	UNIT
View Angle of Half Power	$2\theta_{1/2}$	IF=1000mA		40		deg
Forward Voltage	VF			1.6	1.9	V
Reverse Current	IR	VR=5V			100	μA
Radiant Output Power *2	Po	IF=1000mA	180	320		mw/sr
Peak Emission Wavelength	λ_p			850		nm
Spectrum Width Of Half Valve	$\Delta \lambda$			40		nm
Rise/Fall Time	Tr/Tf			25/15	35/35	ns
Terminal Capacitance	Ct	V=0V F=1MHz		40		pF

*2.Tolerance: 15% HUEY-JANN measuring equipment : EXELTRON 2001. 2.S370 made by U.D.T.

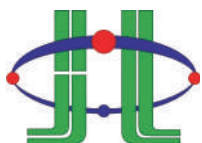

HUEY JANN ELECTRONICS INDUSTRY CO., LTD.

No.27 Line 466 Sec.2,Cannng-nan Rd. Wu-chi Town Taichung Shien, Taiwan, R.O.C.

TEL:+886-4-26393976 FAX:+886-4-26393125

ELECTRIC-OPTICAL CHARACTERISTICS FOR HIRPD8-1Gbx

TA=25°C

PARAMETER	SYMBOL	TEST CONDITION	MIN	TYP	MAX	UNIT
View Angle of Half Power	$2\theta_{1/2}$	IF=500mA		40		deg
Forward Voltage	VF			1.7	2.0	V
Reverse Current	IR	VR=5V			100	μA
Radiant Output Power *2	Po	IF=500mA	75	135		mw/sr
Peak Emission Wavelength	λ_p			850		nm
Spectrum Width Of Half Valve	$\Delta \lambda$			40		nm
Rise/Fall Time	Tr/Tf			25/15	35/35	ns
Terminal Capacitance	Ct	V=0V F=1MHz		40		pF

*2.Tolerance: 15% HUEY-JANN measuring equipment : EXELTRON 2001. 2.S370 made by U.D.T.

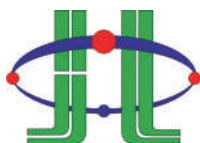

HUEY JANN ELECTRONICS INDUSTRY CO., LTD.

No.27 Line 466 Sec.2,Cannng-nan Rd. Wu-chi Town Taichung Shien, Taiwan, R.O.C.

TEL:+886-4-26393976 FAX:+886-4-26393125

RELIABILITY TEST

➤ Endurance Test

Test Item	Reference Standard	Test Conditions	Result
Operation Life	MIL-STD-750:1026 MIL-STD-883:1005 JIS-C-7021 :B-1	Connect with a power if=500~1000mA Ta=Under room temperature Test Time=1,000hrs	0/22
High Temperature High Humidity Storage	MIL-STD-202:103B JIS-C-7021 :B-11	Ta=+85°C 5°C RH=80% ~ 85% Test Time=1,000hrs	0/22
High Temperature Storage	MIL-STD-883:1008 JIS-C-7021 :B-10	High Ta=+ 120°C 5°C Test Time=1,000hrs	0/22
Low Temperature Storage	JIS-C-7021 :B-12	Low Ta=-40°C 5°C Test Time=1,000hrs	0/22

*Failure Criteria:

1. VF arise \geq 10%
2. IV decline \geq 30%
3. A failure is an LED that is open or shorted

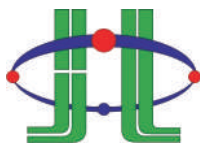

HUEY JANN ELECTRONICS INDUSTRY CO., LTD.

No.27 Line 466 Sec.2,Cannng-nan Rd. Wu-chi Town Taichung Shien, Taiwan, R.O.C.

TEL:+886-4-26393976 FAX:+886-4-26393125

RELIABILITY TEST

➤ Environmental Test

Test Item	Reference Standard	Test Conditions	Result
Temperature Cycling	MIL-STD-202:107D MIL-STD-750:1051 MIL-STD-883:1010 JIS-C-7021 :A-4	-40°C ~ +25°C ~ +85°C ~ +25°C 60min 20min 60min 20min Test Time=200cycle	0/22
Thermal Shock	MIL-STD-202:107D MIL-STD-750:1051 MIL-STD-883:1010	-40°C 5°C ~ +110°C 5°C 20min 20min Test Time=200cycle	0/22

*Failure Criteria:

1. VF arise \geq 10%
2. IV decline \geq 30%
3. A failure is an LED that is open or shorted



HUEY JANN ELECTRONICS INDUSTRY CO., LTD.

No.27 Line 466 Sec.2,Cannng-nan Rd. Wu-chi Town Taichung Shien, Taiwan, R.O.C.

TEL:+886-4-26393976 FAX:+886-4-26393125

TYPICAL ELECTRICAL OPTICAL CHARACTERISTICS CURVES

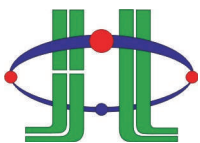
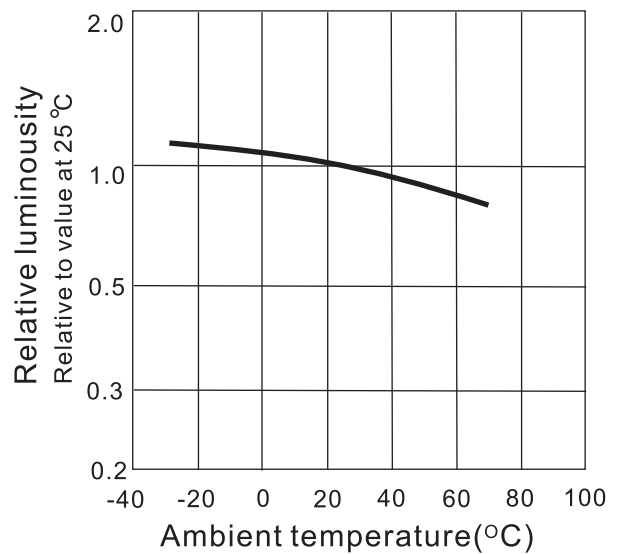
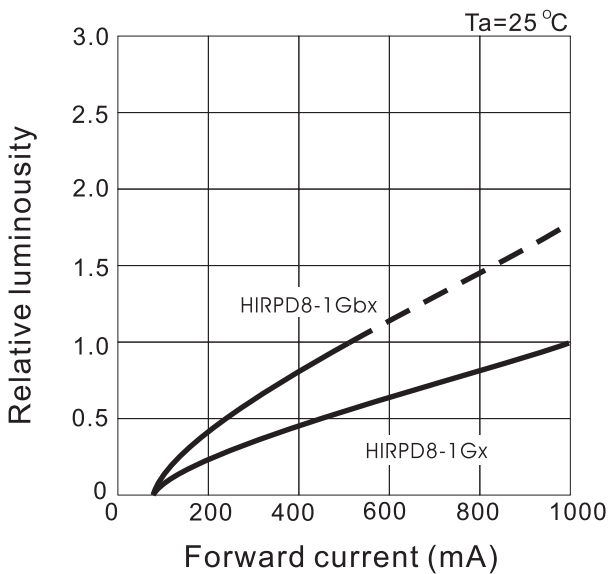
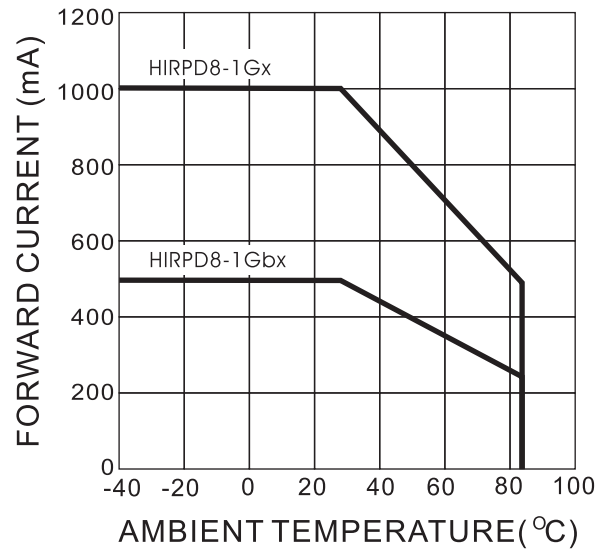
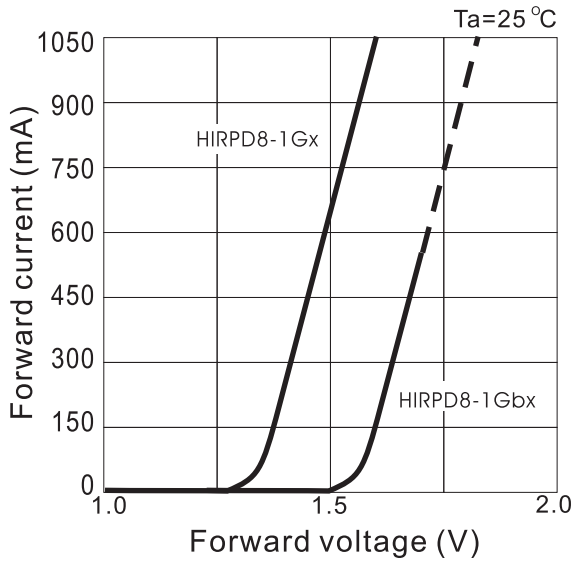

HUEY JANN ELECTRONICS INDUSTRY CO., LTD.

No.27 Line 466 Sec.2,Cannng-nan Rd. Wu-chi Town Taichung Shien, Taiwan, R.O.C.

TEL:+886-4-26393976 FAX:+886-4-26393125

TYPICAL ELECTRICAL OPTICAL CHARACTERISTICS CURVES

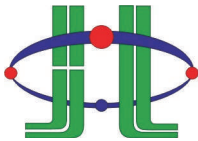
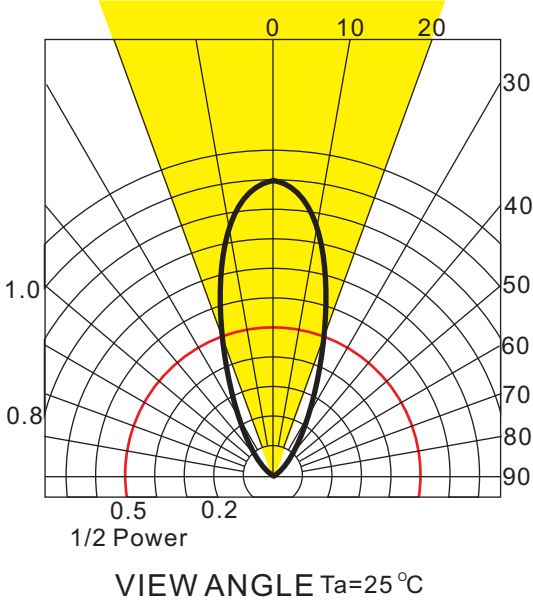
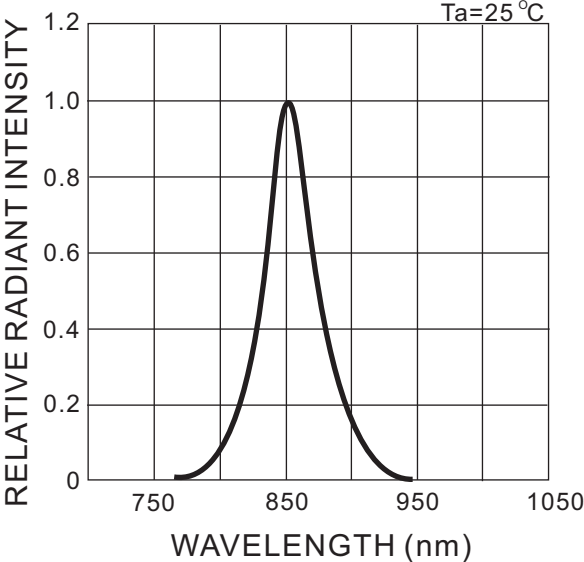

HUEY JANN ELECTRONICS INDUSTRY CO., LTD.
No.27 Line 466 Sec.2,Canng-nan Rd. Wu-chi Town Taichung Shien, Taiwan, R.O.C.
TEL:+886-4-26393976 FAX:+886-4-26393125

LED VF Bin Selection

HIRPD8-1Gx

Brightness Code		
BIN CODE	Brightness in lm	
	Minimum	Maximum
b	1.4	1.6
c	1.6	1.8
d	1.8	2.0

HIRPD8-1Gbx

Brightness Code		
BIN CODE	Brightness in lm	
	Minimum	Maximum
b	1.4	1.6
c	1.6	1.8
d	1.8	2.0

NOTE:

1. Test Condition at IF=500~1000mA.
2. Voltage tolerance for each bin limit is $\pm 0.03V$

Brightness Bin Selection

HIRPD8-1Gx

Brightness Code		
BIN CODE	Brightness in lm	
	Minimum	Maximum
9	140	200
10	200	280
11	280	360
12	360	440

HIRPD8-1Gbx

Brightness Code		
BIN CODE	Brightness in lm	
	Minimum	Maximum
7	80	100
8	100	140
9	140	200

NOTE:

1. Test Condition at IF=500~1000mA.
2. Brightness tolerance for each bin limit is $\pm 15\%$

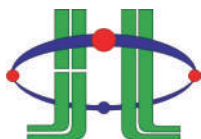

HUEY JANN ELECTRONICS INDUSTRY CO., LTD.

No.27 Line 466 Sec.2, Canng-nan Rd. Wu-chi Town Taichung Shien, Taiwan, R.O.C.

TEL:+886-4-26393976 FAX:+886-4-26393125

Package Dimension For Emitter Type

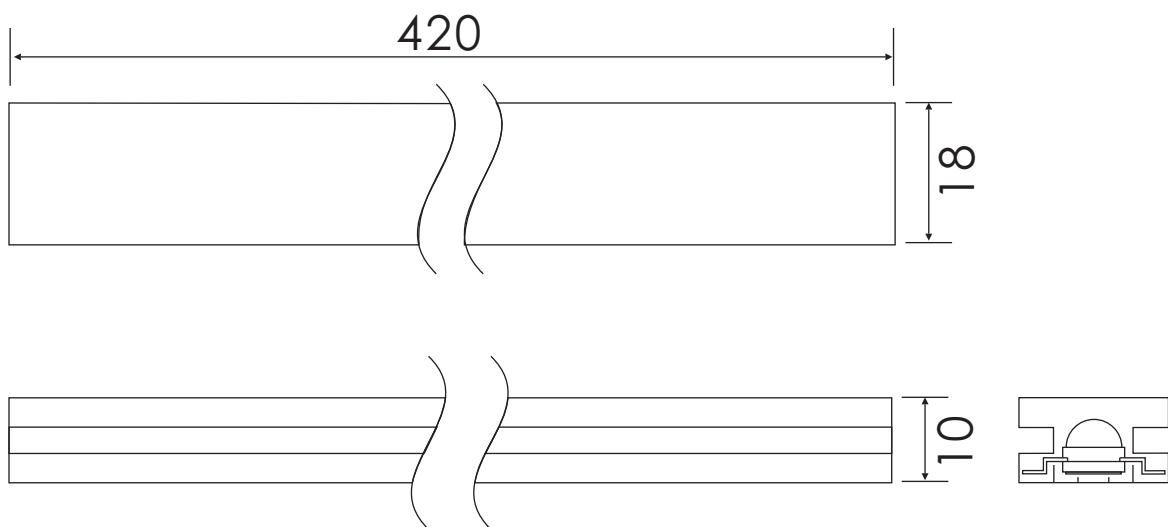

NOTE:

1. Dimensions are specified as follows: mm.
2. Tolerance is 0.3mm unless otherwise noted.
3. 50 pcs emitters per tube.
4. 80 tubes per inside box.
5. 4 inside box per outside box.

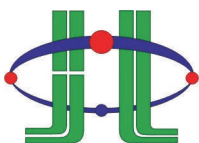

HUEY JANN ELECTRONICS INDUSTRY CO., LTD.

No.27 Line 466 Sec.2,Canng-nan Rd. Wu-chi Town Taichung Shien, Taiwan, R.O.C.

TEL:+886-4-26393976 FAX:+886-4-26393125

Package Dimension For Star Type

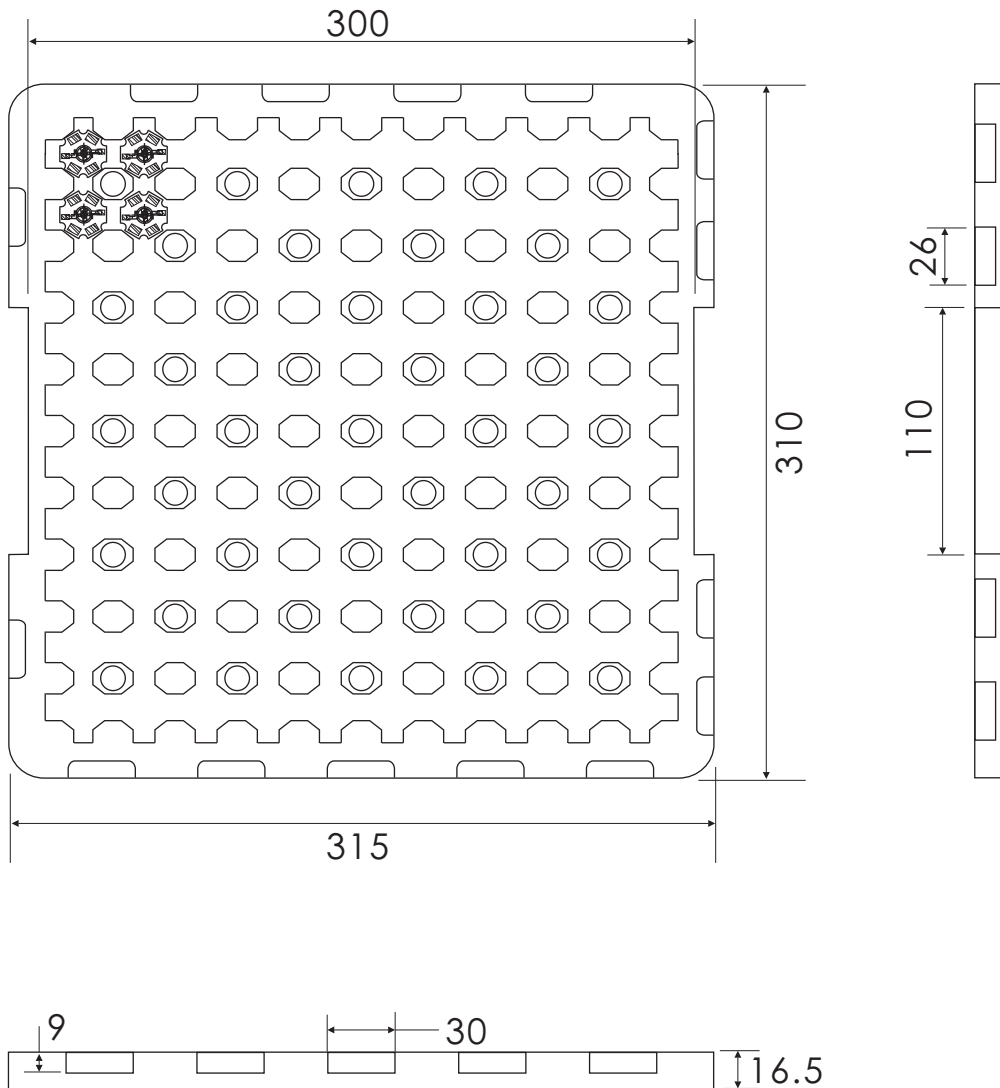

NOTE:

1. Dimensions are specified as follows: mm.
2. Tolerance is 0.3mm unless otherwise noted.
3. 100pcs star per tray.
4. 10 trays per box.

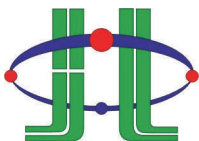

HUEY JANN ELECTRONICS INDUSTRY CO., LTD.

No.27 Line 466 Sec.2,Canng-nan Rd. Wu-chi Town Taichung Shien, Taiwan, R.O.C.

TEL:+886-4-26393976 FAX:+886-4-26393125

Requirements to user For Emitter Type

The LED products by HUEY-JANN is designed, manufactured, and sold aiming at high standard quality and reliability, however, reliability of electronic apparatus is seen as a product of reliability superior to HUEY-JANN and using status at users. From this point, HUEY-JANN requests user's for following things.

Recommended Solder Pad Design For Emitter Type

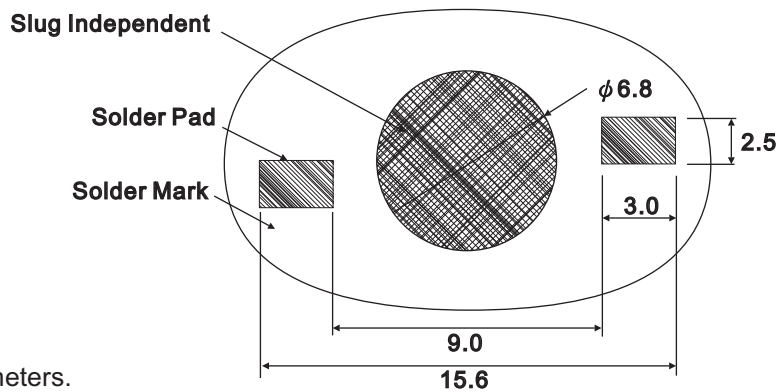

Note:

- 1.All dimensions are in millimeters.
- 2.Electrical isolation is required between Slug and Solder Pad.

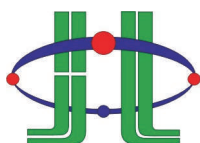

HUEY JANN ELECTRONICS INDUSTRY CO., LTD.

No.27 Line 466 Sec.2,Cannng-nan Rd. Wu-chi Town Taichung Shien, Taiwan, R.O.C.

TEL:+886-4-26393976 FAX:+886-4-26393125

Heat Plate Soldering Condition For Emitter Type

a. Soldering Process for Solder Paste

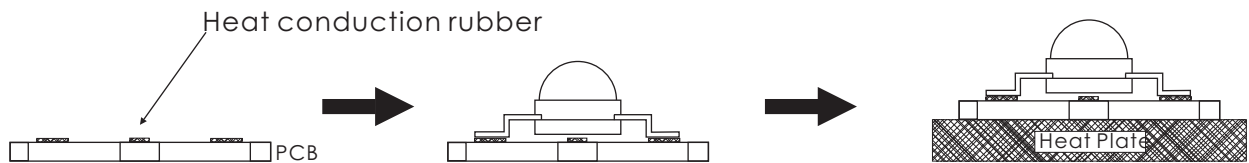

Use Solder Mask to print Solder Paste on PCB.

Place Emitter on PCB.

Put PCB on Heat Plate until Solder Paste melt.

- 1.The Solder Paste should be melted within 10 seconds.
- 2.Take out PCB out from Heat Plate within 15 seconds.

b. Soldering Process for Solder Wire

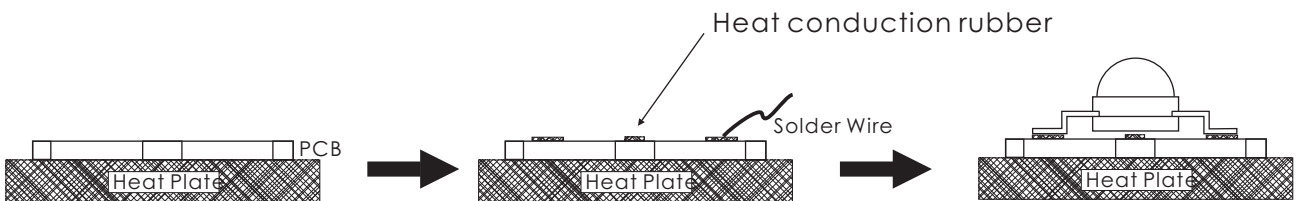

Put PCB on Heat Plate.

Place Solder Wire to the solder pad of PCB.

Put Emitter on PCB. Take the PCB out from Heat Plate within 10 seconds.

NOTE:

- 1.Heat plate temperature: 230°C max for Lead Solder and 260°C max for Lead-Free Solder.
- 2.When soldering, do not put stress on the LEDs during heating.
- 3.After soldering, do not warp the circuit board.

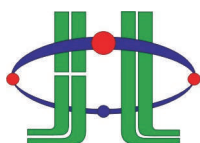

HUEY JANN ELECTRONICS INDUSTRY CO., LTD.

No.27 Line 466 Sec.2,Cannng-nan Rd. Wu-chi Town Taichung Shien, Taiwan, R.O.C.

TEL:+886-4-26393976 FAX:+886-4-26393125

Soldering Process For Hot Bar For Emitter Type

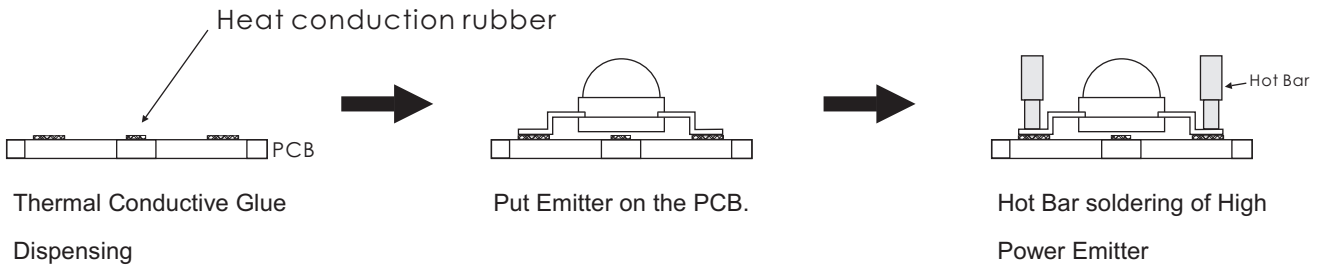

NOTE:

1. Hot Bar temperature: 230°C max for Lead Solder and 260°C max for Lead-Free Solder.
2. When soldering, do not put stress on the LEDs during heating.
3. After soldering, do not warp the circuit board.

Manual Hand Soldering For Emitter Type

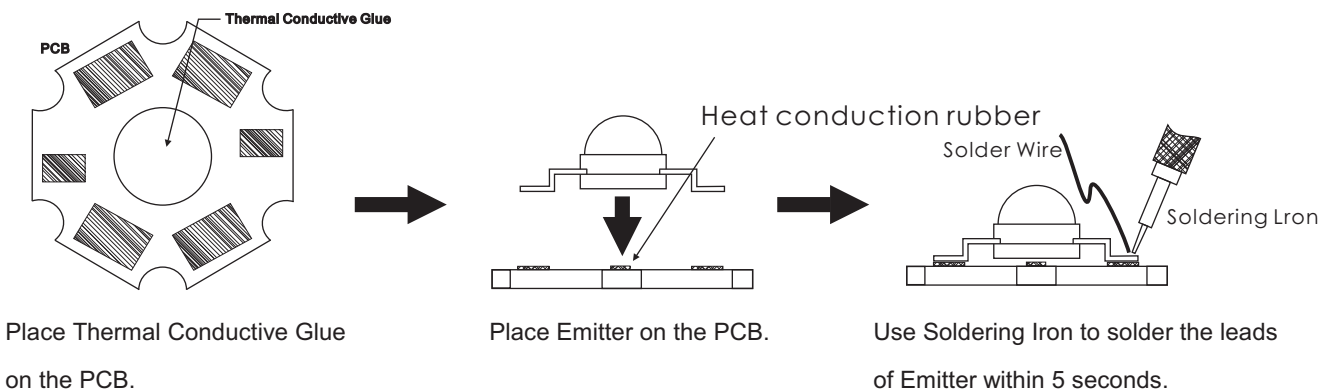

1. Solder tip temperature: 230°C max for Lead Solder and 260°C max for Lead-Free Solder.
2. Avoiding damage to the emitter or to the PCB dielectric layer. Damage to the epoxy layer can cause
3. Do not let the solder contact from solder pad to back-side of PCB. This one will cause a short circuit and damage emitter.

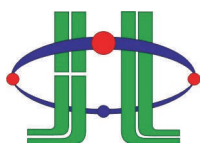

HUEY JANN ELECTRONICS INDUSTRY CO., LTD.

No.27 Line 466 Sec.2, Cangg-nan Rd. Wu-chi Town Taichung Shien, Taiwan, R.O.C.

TEL:+886-4-26393976 FAX:+886-4-26393125

TAB Temperature - Life Characteristics Curves

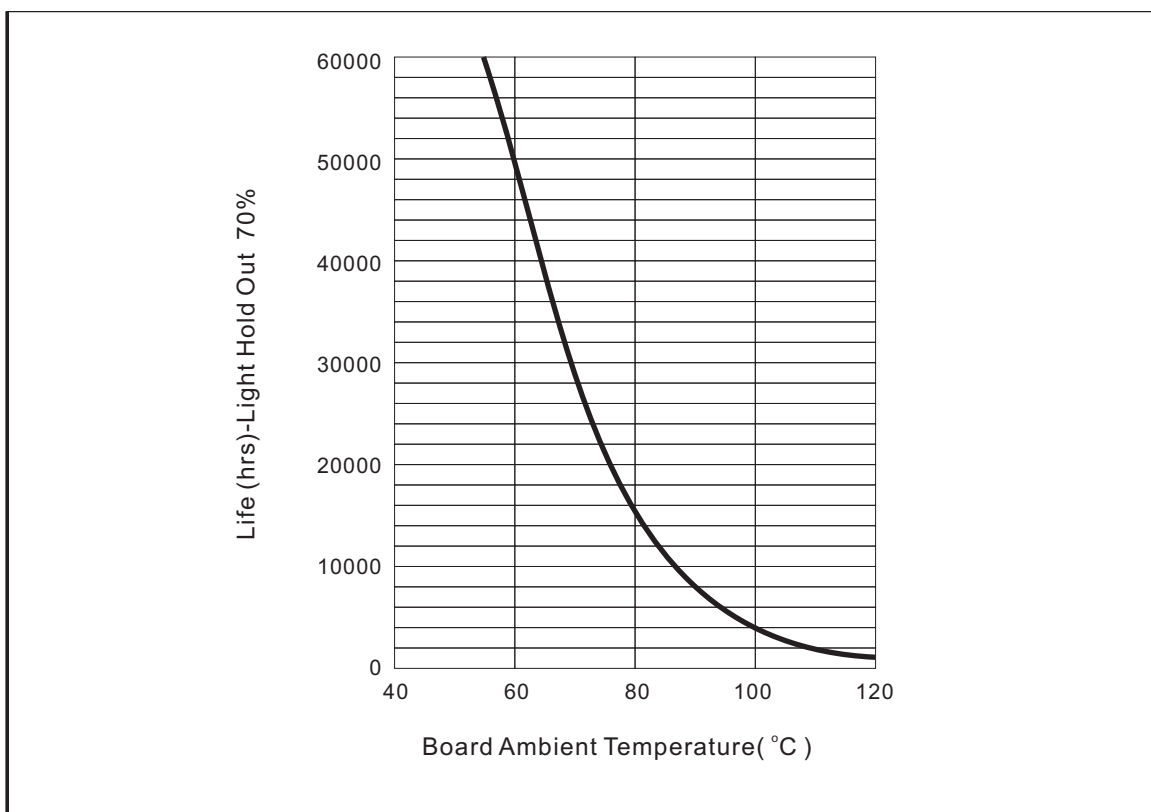
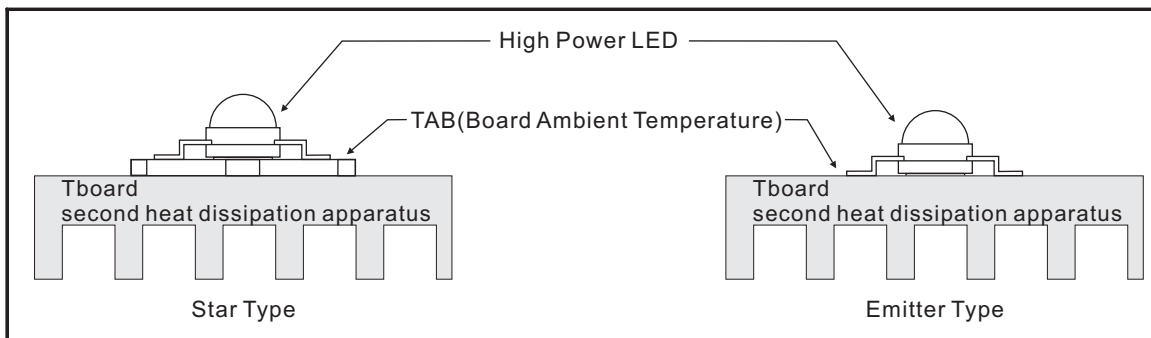

*Board Ambient Temperature Tolerance 5°C.

*TAB in this table is according to highest operating temperature 65°C.

*The TAB is the stable testing value for the product lighted 100% after one hour.

*Different materials of second heat dissipation device, the surface area of heat sink will be different. Thus, this document is for reference only.



HUEY JANN ELECTRONICS INDUSTRY CO., LTD.

No.27 Line 466 Sec.2,Canng-nan Rd. Wu-chi Town Taichung Shien, Taiwan, R.O.C.

TEL:+886-4-26393976 FAX:+886-4-26393125