

VISIBLE LIGHT PRODUCTS SPECIFICATION

HIRTLB2-4E



Drawn by	Checked by	Approved by



DATE:2009/1/20

REV:E



HUEY JANN ELECTRONICS INDUSTRY CO., LTD.

No.27 Line 466 Sec.2,Cannng-nan Rd. Wu-chi Town Taichung Shien, Taiwan, R.O.C.

TEL:+886-4-26393976 FAX:+886-4-26393125

DEVICES

Part Number	Lens		Source	
	Color	Diffusion	Dice Source	Color
HIRTLB2-4E	Water clear	Non-Diffused	GaAlAs/GaAs	Infrared

PACKAGE DIMENSIONS

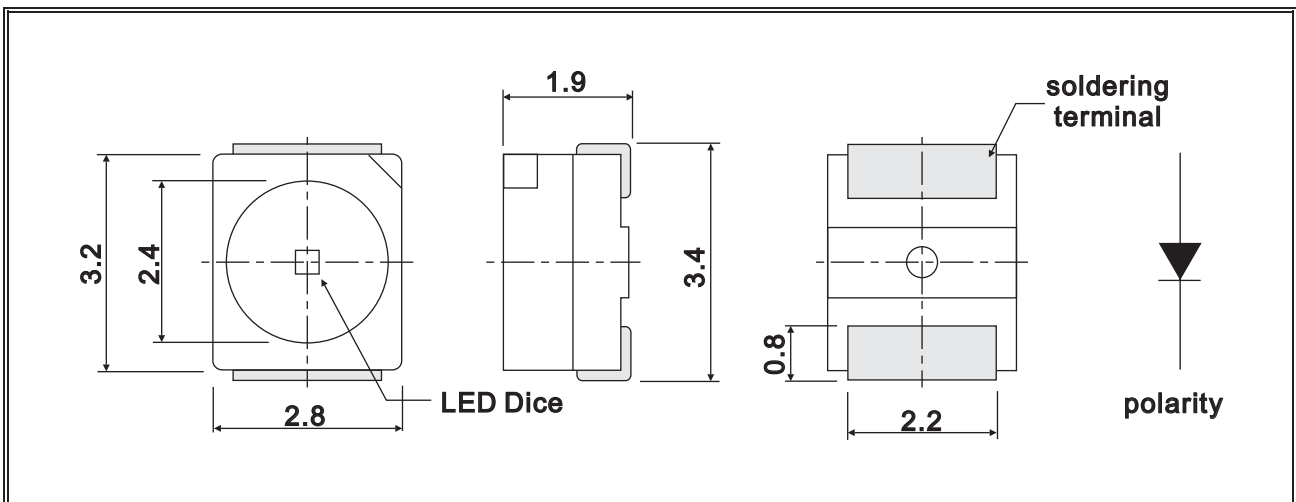

NOTE:

- 1.All dimensions are in millimeter.
- 2.specifications are subject to change without notice.
- 3.Tolerance is $\pm 0.3\text{mm}$ unless otherwise noted.

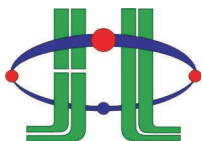

HUEY JANN ELECTRONICS INDUSTRY CO., LTD.

No.27 Line 466 Sec.2,Cannng-nan Rd. Wu-chi Town Taichung Shien, Taiwan,
R.O.C.

TEL:+886-4-26393976 FAX:+886-4-26393125

RECOMMENDED SOLDERING PATTERN

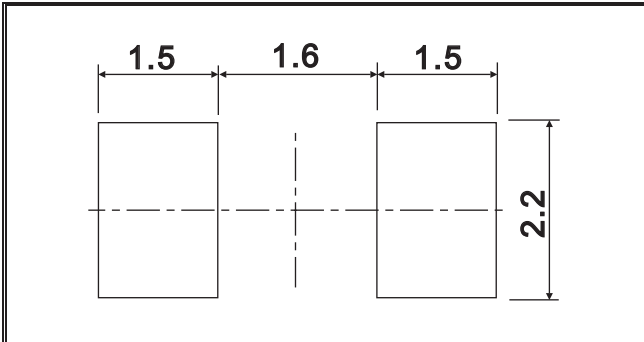

NOTE:

- 1.All dimensions are in millimeter.
- 2.specifications are subject to change without notice.

TAPE SPECIFICATIONS

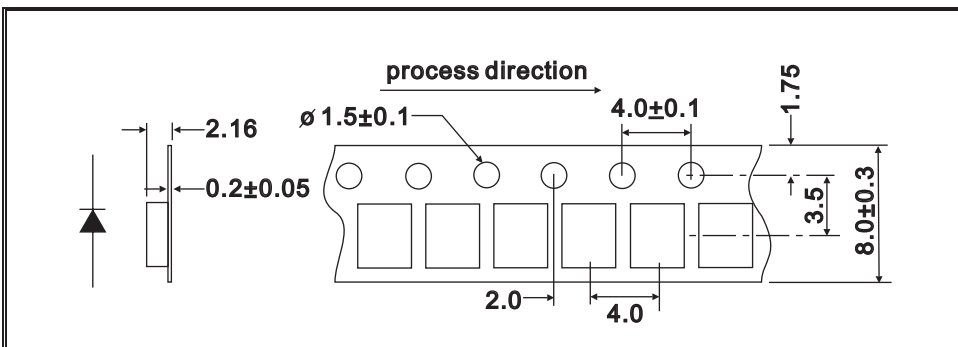

NOTE:

- 1.All dimensions are in millimeter.
- 2.specifications are subject to change without notice.

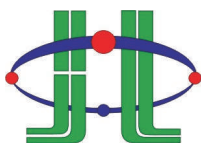

HUEY JANN ELECTRONICS INDUSTRY CO., LTD.

No.27 Line 466 Sec.2,Cannng-nan Rd. Wu-chi Town Taichung Shien, Taiwan, R.O.C.

TEL:+886-4-26393976 FAX:+886-4-26393125

ABSOLUTE MAXIMUM RATINGS

TA=25°C

PARAMETER	SYMBOL	MAX. RATING	UNIT
Power Dissipation	Pd	80	mW
Continuous Forward Current	IF	50	mA
Peak Forward Current *1	IFM	100	mA
Reverse Voltage	VR	5	V
LED Junction Temperature	Tj	100	°C
Operating Temperature	Topr	-40 ~ +85	°C
Storage Temperature	Tstg	-40 ~ +100	°C
Reflow Soldering (preheat 150 ~ 180°C 60 ~ 120 sec, solder temp 260°C 10 sec)			

*1.Duty Ratio = 1/10, Pulse Width = 0.1ms.

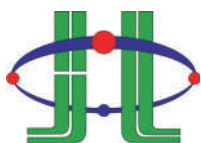

HUEY JANN ELECTRONICS INDUSTRY CO., LTD.

No.27 Line 466 Sec.2,Cannng-nan Rd. Wu-chi Town Taichung Shien, Taiwan, R.O.C.

TEL:+886-4-26393976 FAX:+886-4-26393125

ELECTRIC-OPTICAL CHARACTERISTICS

TA=25°C

PARAMETER	SYMBOL	TEST CONDITION	MIN	TYP	MAX	UNIT
View Angle of Half Power	2θ1/2	IF=20mA		120		deg
Forward Voltage	VF			1.40	1.80	V
Reverse Current	IR	VR=5V			10	μA
Radiant Output Power *2	Po	IF=20mA	0.40	0.85		mw/sr
Peak Emission Wavelength	λp			880		nm
Spectrum Width of Half Valve	Δλ			70		nm

*2. Tolerance: ±15% HUEY-JANN measuring equipment: 1. EXELTON 2001. 2. S370 made by U.D.T.

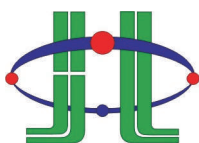

HUEY JANN ELECTRONICS INDUSTRY CO., LTD.

No.27 Line 466 Sec.2, Canng-nan Rd. Wu-chi Town Taichung Shien, Taiwan, R.O.C.

TEL:+886-4-26393976 FAX:+886-4-26393125

RELIABILITY TEST

Classification	Test Item	Reference Standard	Test Conditions	Result
Endurance Test	Operation Life	MIL-STD-750:1026 MIL-STD-883:1005 JIS-C-7021 :B-1	Connect with a power if=20mA Ta=Under room temperature Test Time=1,000hrs	0/22
	High Temperature High Humidity Storage	MIL-STD-202:103B JIS-C-7021 :B-11	Ta=+85°C±5°C RH=90% ~ 95% Test Time=1000hrs	0/22
	High Temperature Storage	MIL-STD-883:1008 JIS-C-7021 :B-10	High Ta=+100°C±5°C Test Time=1,000hrs	0/22
	Low Temperature Storage	JIS-C-7021 :B-12	Low Ta=-40°C±5°C Test Time=1,000hrs	0/22
	Temperature Cycling	MIL-STD-202:107D MIL-STD-750:1051 MIL-STD-883:1010 JIS-C-7021 :A-4	-40°C ~ +25°C ~ +85°C ~ +25°C 60min 20min 60min 20min Test Time=200cycle	0/22
Environmental Test	Thermal Shock	MIL-STD-202:107D MIL-STD-750:1051 MIL-STD-883:1010	-40°C±5°C ~ +85°C±5°C 20min 20min Test Time=200cycle	0/22

*Failure Criteria:

1. VF arise $\geq 10\%$
2. IV decline $\geq 30\%$
3. A failure is an LED that is open or shorted

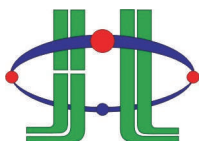

HUEY JANN ELECTRONICS INDUSTRY CO., LTD.

No.27 Line 466 Sec.2,Cannng-nan Rd. Wu-chi Town Taichung Shien, Taiwan, R.O.C.

TEL:+886-4-26393976 FAX:+886-4-26393125

TYPICAL ELECTRICAL OPTICAL CHARACTERISTICS CURVES

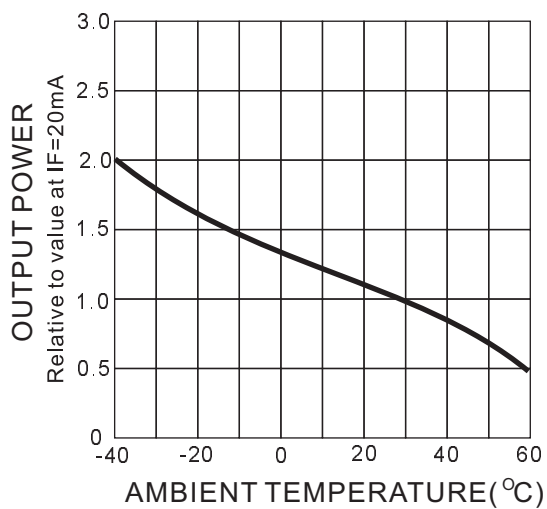
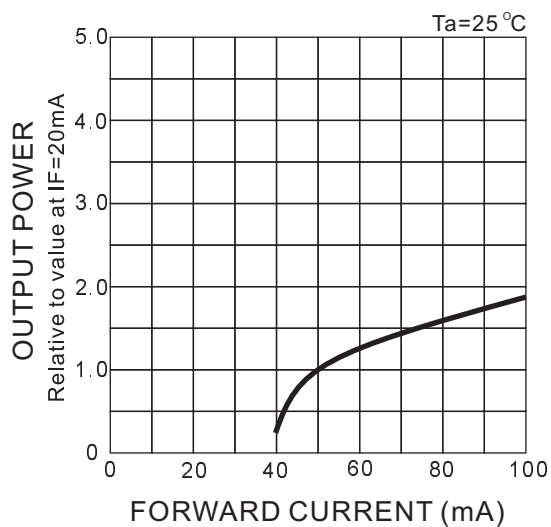
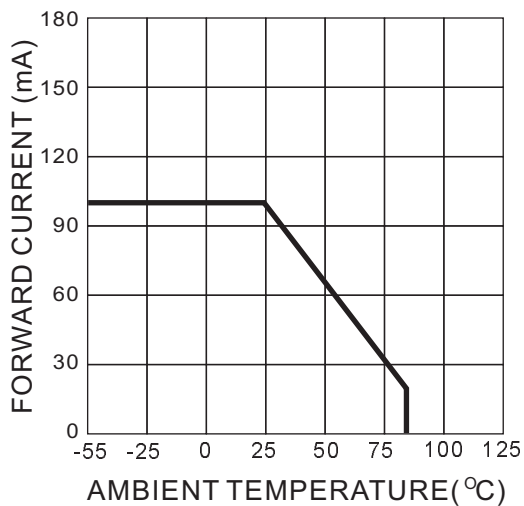
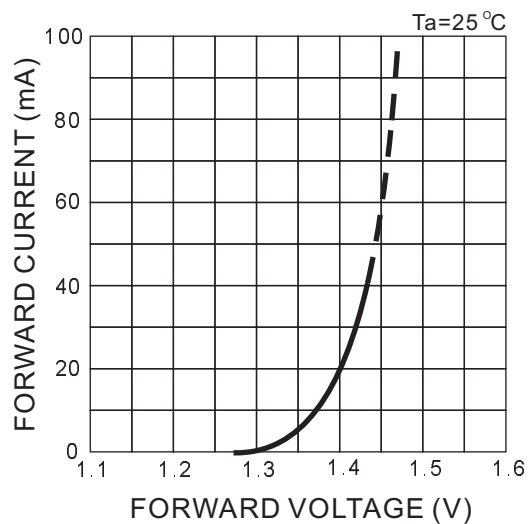

HUEY JANN ELECTRONICS INDUSTRY CO., LTD.

No.27 Line 466 Sec.2,Canng-nan Rd. Wu-chi Town Taichung Shien, Taiwan, R.O.C.

TEL:+886-4-26393976 FAX:+886-4-26393125

TYPICAL ELECTRICAL OPTICAL CHARACTERISTICS CURVES

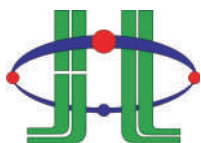
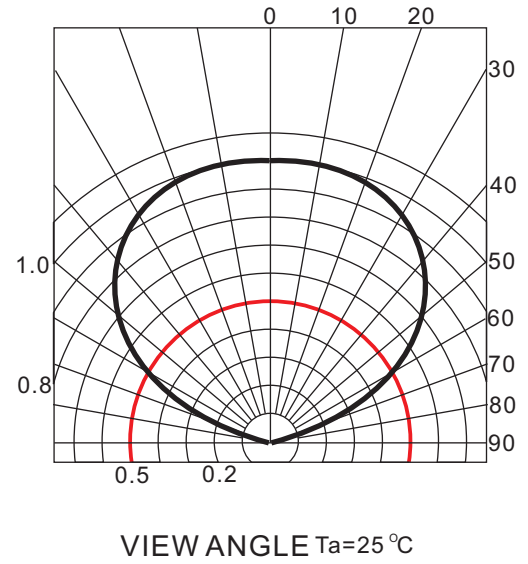
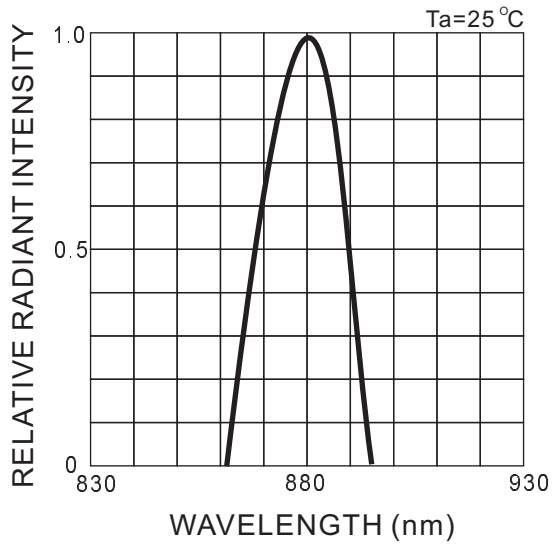

HUEY JANN ELECTRONICS INDUSTRY CO., LTD.

No.27 Line 466 Sec.2,Canng-nan Rd. Wu-chi Town Taichung Shien, Taiwan, R.O.C.

TEL:+886-4-26393976 FAX:+886-4-26393125