

VISIBLE LIGHT PRODUCTS SPECIFICATION

HB3b-449AWF



Drawn by	Checked by	Approved by



DATE:2010/7/8

REV.J

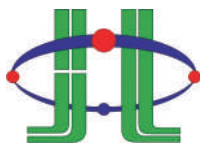

HUEY JANN ELECTRONICS INDUSTRY CO., LTD.

No.27 Line 466 Sec.2,Canng-nan Rd. Wu-chi Town Taichung Shien, Taiwan, R.O.C.

TEL:+886-4-26393976 FAX:+886-4-26393125

DEVICES

Part Number	Lens		Source	
	Color	Diffusion	Dice Source	Color
HB3b-449AWF	Water Clear	Non-Diffusion	GaNN/GaN	Super White

PACKAGE DIMENSIONS:

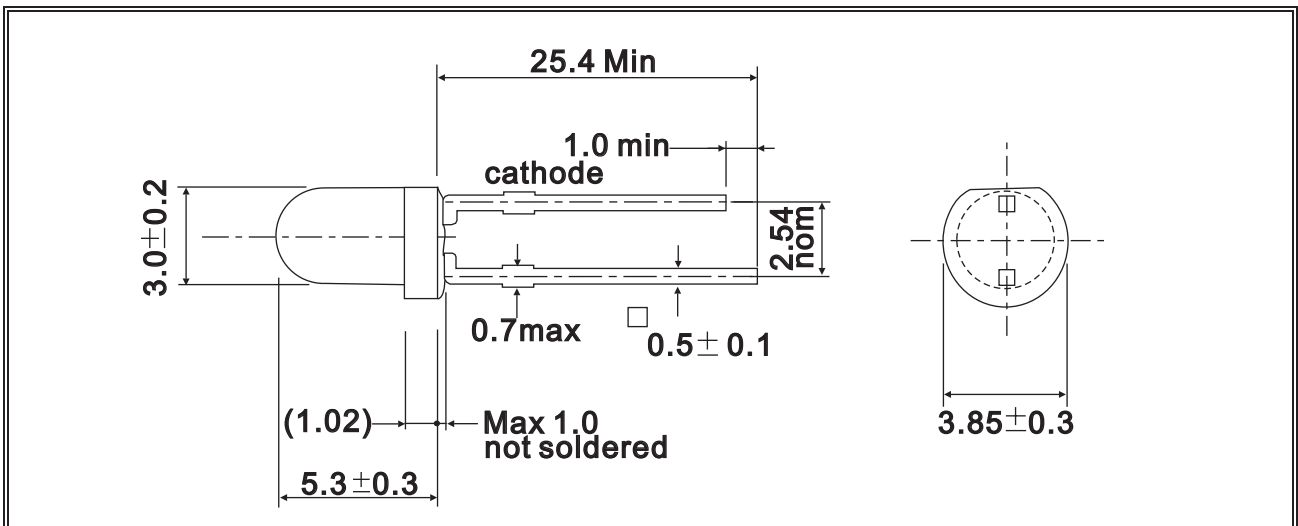

NOTE:

- 1.All dimensions are in millimeter.
- 2.Lead spacing is measured where the lead emerge from the package.
- 3.Protruded resin under flange is 1.5mm max.
- 4.Specifications are subject to change without notice.
- 5.Tolerance is 0.3mm unless otherwise noted.

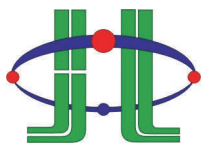

HUEY JANN ELECTRONICS INDUSTRY CO., LTD.

No.27 Line 466 Sec.2,Canng-nan Rd. Wu-chi Town Taichung Shien, Taiwan, R.O.C.

TEL:+886-4-26393976 FAX:+886-4-26393125

ABSOLUTE MAXIMUM RATINGS

TA=25°C

PARAMETER	SYMBOL	MAX. RATING	UNIT
Continuous Forward Current	IF	25	mA
Peak Forward Current *1	IFM	100	mA
Reverse Voltage	VR	4	V
Electrostatic Discharge (HBM)	ESD	150	V
LED Junction Temperature	Tj	100	°C
Operating Temperature	Topr	-40 ~ +85	°C
Storage Temperature	Tstg	-40 ~ +100	°C
Dip Soldering Temperature (3mm from case Bottom 260 °C for 5 seconds)			

*1.Duty Ratio=0.1%,Pulse Width=10us.

*2.Iron soldering in 350°C within 5 seconds will not cause damage to the dice. But be aware of the high temperature will not only make the epoxy soften but also cause the lead moving and the gold wire broken and even open. So before returning to the normal temperature PLEASE AVOID any serious pressure on the top of epoxy and lead.

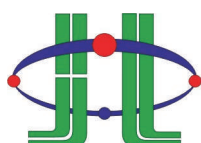

HUEY JANN ELECTRONICS INDUSTRY CO., LTD.

No.27 Line 466 Sec.2,Cannng-nan Rd. Wu-chi Town Taichung Shien, Taiwan, R.O.C.

TEL:+886-4-26393976 FAX:+886-4-26393125

ELECTRIC-OPTICAL CHARACTERISTICS

TA=25°C

PARAMETER	SYMBOL	TEST CONDITION	MIN	TYP	MAX	UNIT
View Angle of Half Power	2θ1/2	IF=20mA		29		deg
Forward Voltage	VF			3.3	3.8	V
Reverse Current	IR	VR=5V			60	μA
Luminous Intensity *2	IV	IF=20mA	12000	21000		mcd
Chromaticity Coordinates (Bin Sorting)	x			0.30		
	y			0.31		
Dominate Wave Length *3	λ d(HUE)			--		nm
Spectrum Width Of Half Valve	Δλ				--	nm

*2.Tolerance: 15% HUEY-JANN measuring equipment : EXELTRON 2001. 2.S370 made by U.D.T.

*3.The dominate wavelength , λ d, is derived from the CIE Chromaticity Diagram and represents the color of the device.

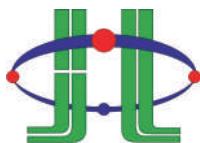

HUEY JANN ELECTRONICS INDUSTRY CO., LTD.

No.27 Line 466 Sec.2,Cannng-nan Rd. Wu-chi Town Taichung Shien, Taiwan, R.O.C.

TEL:+886-4-26393976 FAX:+886-4-26393125

RELIABILITY TEST

Classification	Test Item	Reference Standard	Test Conditions	Result
Endurance Test	Operation Life	MIL-STD-750:1026 MIL-STD-883:1005 JIS-C-7021 :B-1	Connect with a power if=20mA Ta=Under room temperature Test Time=1,000hrs	0/22
	High Temperature High Humidity Storage	MIL-STD-202:103B JIS-C-7021 :B-11	Ta=+85°C 5°C RH=90% ~ 95% Test Time=1000hrs	0/22
	High Temperature Storage	MIL-STD-883:1008 JIS-C-7021 :B-10	High Ta=+100°C 5°C Test Time=1,000hrs	0/22
	Low Temperature Storage	JIS-C-7021 :B-12	Low Ta=-40°C 5°C Test Time=1,000hrs	0/22
	Environmental Test	Temperature Cycling	MIL-STD-202:107D MIL-STD-750:1051 MIL-STD-883:1010 JIS-C-7021 :A-4	-40°C ~ +25°C ~ +85°C ~ +25°C 60min 20min 60min 20min Test Time=200cycle
Thermal Shock		MIL-STD-202:107D MIL-STD-750:1051 MIL-STD-883:1010	-40°C 5°C ~ +85°C 5°C 20min 20min Test Time=200cycle	0/22

*Failure Criteria:

1. VF arise $\geq 10\%$
2. IV decline $\geq 30\%$
3. A failure is an LED that is open or shorted

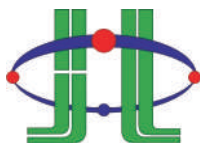

HUEY JANN ELECTRONICS INDUSTRY CO., LTD.

No.27 Line 466 Sec.2,Cannng-nan Rd. Wu-chi Town Taichung Shien, Taiwan, R.O.C.

TEL:+886-4-26393976 FAX:+886-4-26393125

TYPICAL ELECTRICAL OPTICAL CHARACTERISTICS CURVES

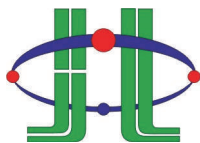
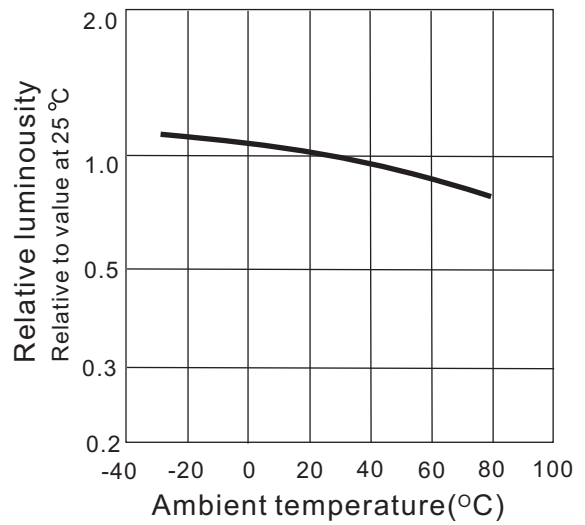
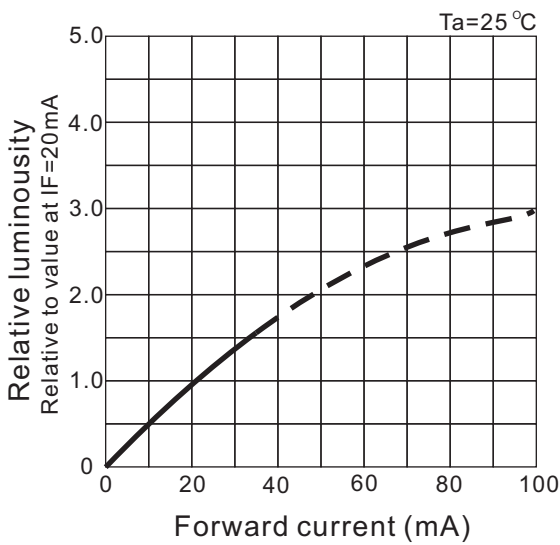
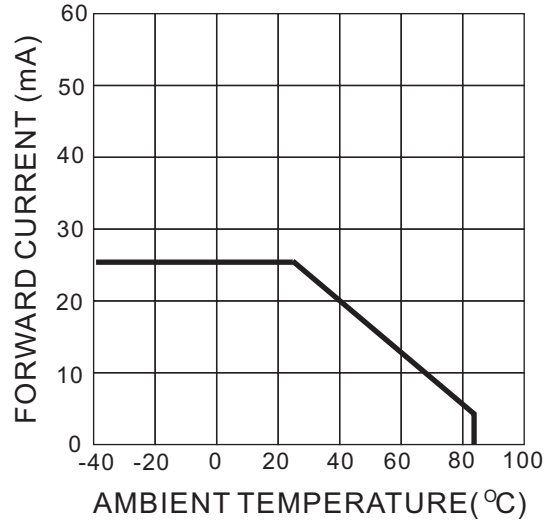
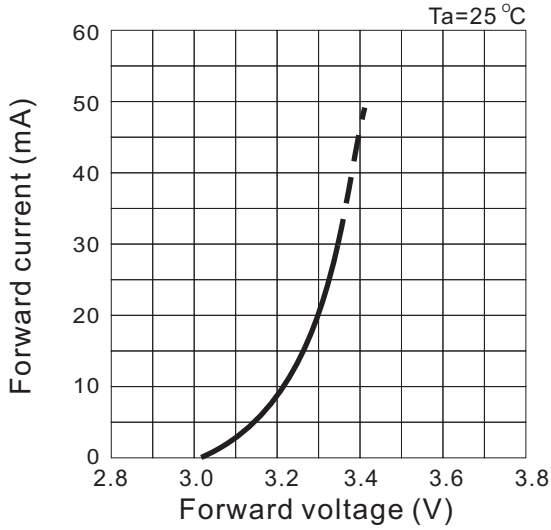

HUEY JANN ELECTRONICS INDUSTRY CO., LTD.

No.27 Line 466 Sec.2,Cannng-nan Rd. Wu-chi Town Taichung Shien, Taiwan, R.O.C.

TEL:+886-4-26393976 FAX:+886-4-26393125

TYPICAL ELECTRICAL OPTICAL CHARACTERISTICS CURVES

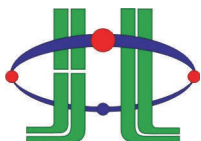
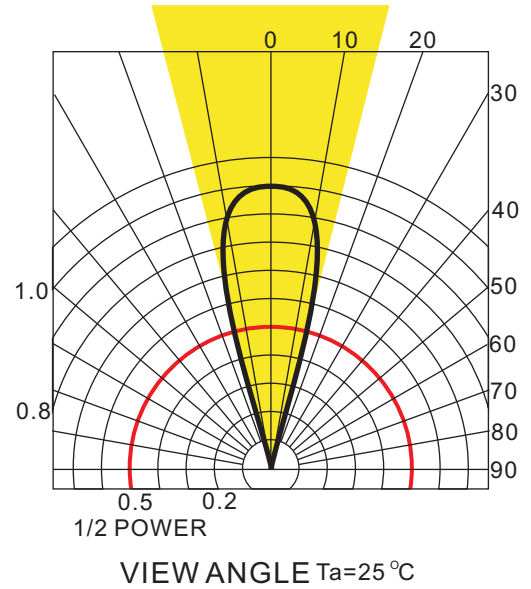
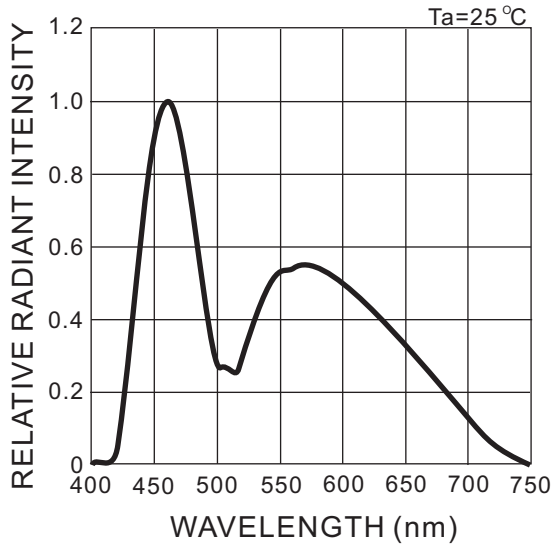

HUEY JANN ELECTRONICS INDUSTRY CO., LTD.

No.27 Line 466 Sec.2,Canng-nan Rd. Wu-chi Town Taichung Shien, Taiwan, R.O.C.

TEL:+886-4-26393976 FAX:+886-4-26393125

LED VF Bin Selection

$I_F=20\text{mA}$

BIN CODE	Forward Voltage	
	Minimum	Maximum
k	3.2	3.4
m	3.4	3.6
n	3.6	3.8

Voltage tolerance for each bin limit is $\pm 0.03\text{V}$

Brightness Code

$I_F=20\text{mA}$

BIN CODE	Brightness in mcd	
	Minimum	Maximum
Z1	16000	21000
Z2	21000	27000
Z3	27000	35000
Z4	35000	45000

Brightness tolerance for each bin limit is $\pm 15\%$

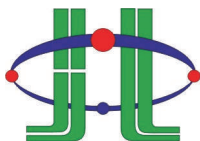

HUEY JANN ELECTRONICS INDUSTRY CO., LTD.

No.27 Line 466 Sec.2, Canng-nan Rd. Wu-chi Town Taichung Shien, Taiwan, R.O.C.

TEL:+886-4-26393976 FAX:+886-4-26393125

Color Bin Selection

If=20mA

Bin			Chromaticity Coordinates				Bin			Chromaticity Coordinates				
3	3-1	x	0.260	0.270	0.270	0.260	8	8-1	x	0.310	0.320	0.320	0.310	
		y	0.280	0.290	0.270	0.260			8-2	x	0.310	0.320	0.320	0.310
	3-2	x	0.260	0.270	0.270	0.260		9-1		x	0.320	0.330	0.330	0.320
		y	0.260	0.270	0.240	0.230			9-2	x	0.320	0.330	0.330	0.320
4	4-1	x	0.270	0.280	0.280	0.270	9	9-1		y	0.360	0.370	0.350	0.340
		y	0.290	0.300	0.280	0.270			9-2	x	0.340	0.350	0.315	0.305
	4-2	x	0.270	0.280	0.280	0.270		10		10-1	x	0.330	0.340	0.340
		y	0.270	0.280	0.250	0.240			10-2		x	0.330	0.340	0.340
5	5-1	x	0.280	0.290	0.290	0.280	10			10-1	y	0.370	0.380	0.360
		y	0.300	0.310	0.290	0.280			10-2		x	0.350	0.360	0.325
	5-2	x	0.280	0.290	0.290	0.280		11		11-1	x	0.340	0.350	0.350
		y	0.280	0.290	0.260	0.250			11-2		x	0.340	0.350	0.350
6	6-1	x	0.290	0.300	0.300	0.250	11			11-1	y	0.380	0.390	0.370
		y	0.310	0.320	0.300	0.290			11-2		x	0.360	0.370	0.335
	6-2	x	0.250	0.300	0.300	0.290		12		12-1	x	0.350	0.360	0.360
		y	0.290	0.300	0.270	0.260			12-2		y	0.390	0.400	0.380
7	7-1	x	0.300	0.310	0.310	0.300	12			12-1	x	0.350	0.360	0.360
		y	0.320	0.330	0.310	0.300			12-2		x	0.350	0.360	0.360
	7-2	x	0.300	0.310	0.310	0.300		12-2		y	0.370	0.380	0.345	0.335
		y	0.300	0.310	0.280	0.270								
Tolerance			x ± 0.02		y ± 0.02		Tolerance			x ± 0.02		y ± 0.02		

The chromaticity coordinates reading at center of light.

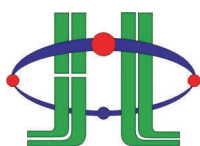

HUEY JANN ELECTRONICS INDUSTRY CO., LTD.

No.27 Line 466 Sec.2,Cannng-nan Rd. Wu-chi Town Taichung Shien, Taiwan, R.O.C.

TEL:+886-4-26393976 FAX:+886-4-26393125

CIE Light Color Chart

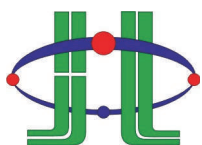
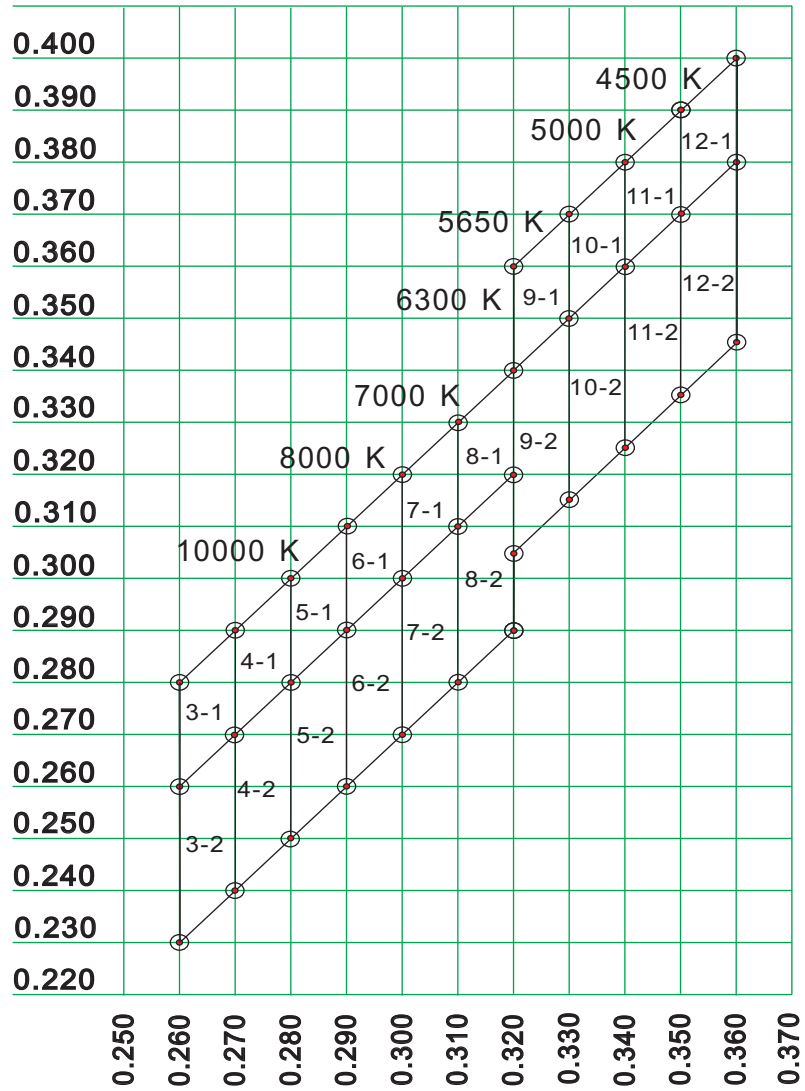

HUEY JANN ELECTRONICS INDUSTRY CO., LTD.

No.27 Line 466 Sec.2, Cangg-nan Rd. Wu-chi Town Taichung Shien, Taiwan, R.O.C.

TEL:+886-4-26393976 FAX:+886-4-26393125