

VISIBLE LIGHT PRODUCTS SPECIFICATION

HB5H-439AWF



Drawn by	Checked by	Approved by



DATE:2008/7/28

REV:C



HUEY JANN ELECTRONICS INDUSTRY CO., LTD.

No.27 Line 466 Sec.2,Canng-nan Rd. Wu-chi Town Taichung Shien, Taiwan, R.O.C.

TEL:+886-4-26393976 FAX:+886-4-26393125

DEVICES

Part Number	Lens		Source	
	Color	Diffusion	Dice Source	Color
HB5H-439AWF	Water Clear	Non-Diffusion	GaInN/GaN	Super White

PACKAGE DIMENSIONS:

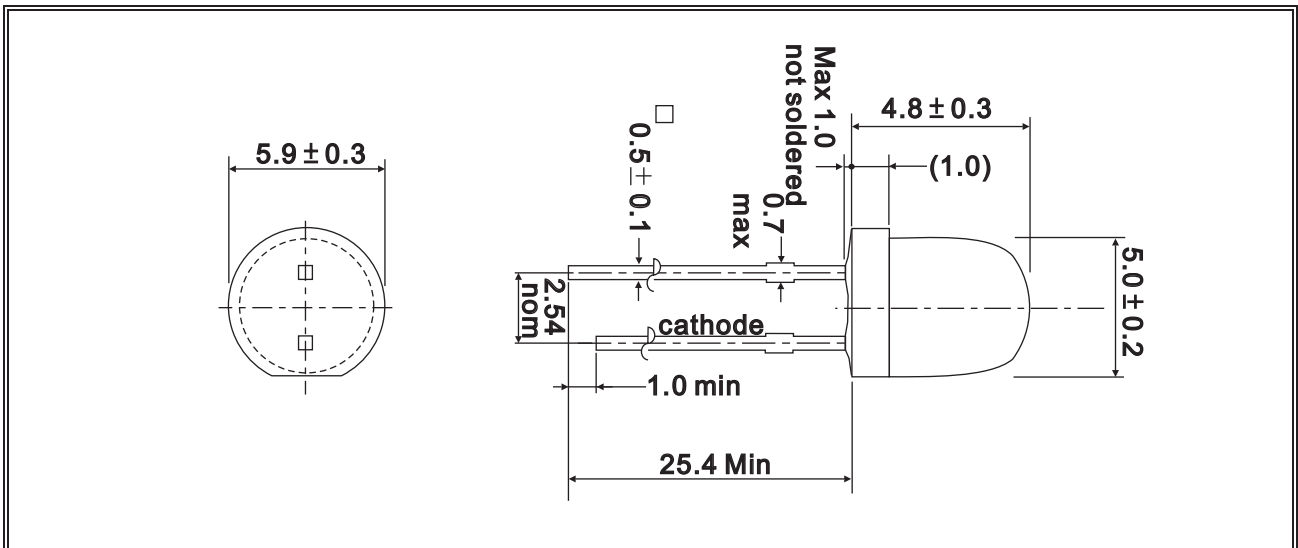

NOTE:

- 1.All dimensions are in millimeter.
- 2.Lead spacing in measured where the lead emerge from the package.
- 3.Prodruded resin under flange is 1.5mm max.
- 4.Specifications are subject to change without notice.
- 5.Tolerance is ± 0.3 mm unless otherwise noted.

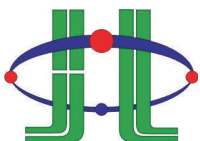

HUEY JANN ELECTRONICS INDUSTRY CO., LTD.

No.27 Line 466 Sec.2,Cannng-nan Rd. Wu-chi Town Taichung Shien, Taiwan, R.O.C.

TEL:+886-4-26393976 FAX:+886-4-26393125

ABSOLUTE MAXIMUM RATINGS

TA=25°C

PARAMETER	SYMBOL	MAX. RATING	UNIT
Continuous Forward Current	IF	30	mA
Peak Forward Current *1	IFM	100	mA
Reverse Voltage	VR	5	V
Electrostatic Discharge (HBM)	ESD	150	V
LED Junction Temperature	Tj	100	°C
Operating Temperature	Topr	-40 ~ +85	°C
Storage Temperature	Tstg	-40 ~ +100	°C
Dip Soldering Temperature (3mm from case Bottom 260 °C for 5 seconds)			

*1.Duty Ratio=0.1%,Pulse Width=10us.

*2.Iron soldering in 350°C within 5 seconds will not cause damage to the dice. But be aware of the high temperature will not only make the epoxy soften but also cause the lead moving and the gold wire broken and even open. So before returning to the normal temperature PLEASE AVOID any serious pressure on the top of epoxy and lead.

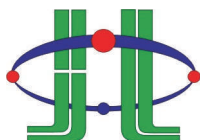

HUEY JANN ELECTRONICS INDUSTRY CO., LTD.

No.27 Line 466 Sec.2,Cannng-nan Rd. Wu-chi Town Taichung Shien, Taiwan, R.O.C.

TEL:+886-4-26393976 FAX:+886-4-26393125

ELECTRIC-OPTICAL CHARACTERISTICS

TA=25°C

PARAMETER	SYMBOL	TEST CONDITION	MIN	TYP	MAX	UNIT
View Angle of Half Power	2θ1/2	IF=20mA		65		deg
Forward Voltage	VF			3.3	3.8	V
Reverse Current	IR	VR=5V			60	μA
Luminous Intensity *2	IV	IF=20mA	1800	3500		mcd
Chromaticity Coordinates (Bin Sorting)	x			0.30		
	y			0.31		
Dominate Wave Length *3	λ d(HUE)			---		nm
Spectrum Width Of Half Valve	Δλ				---	nm

*2.Tolerance:±15% HUEY-JANN measuring equipment : EXELTRON 2001. 2.S370 made by U.D.T.

*3.The dominate wavelength , λ d, is derived from the CIE Chromaticity Diagram and represents the color of the device.

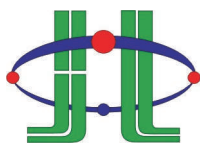

HUEY JANN ELECTRONICS INDUSTRY CO., LTD.

No.27 Line 466 Sec.2,Cannng-nan Rd. Wu-chi Town Taichung Shien, Taiwan, R.O.C.

TEL:+886-4-26393976 FAX:+886-4-26393125

RELIABILITY TEST

Classification	Test Item	Reference Standard	Test Conditions	Result
Endurance Test	Operation Life	MIL-STD-750:1026 MIL-STD-883:1005 JIS-C-7021 :B-1	Connect with a power if=20mA Ta=Under room temperature Test Time=1,000hrs	0/22
	High Temperature High Humidity Storage	MIL-STD-202:103B JIS-C-7021 :B-11	Ta=+85°C±5°C RH=90% ~ 95% Test Time=1000hrs	0/22
	High Temperature Storage	MIL-STD-883:1008 JIS-C-7021 :B-10	High Ta=+100°C±5°C Test Time=1,000hrs	0/22
	Low Temperature Storage	JIS-C-7021 :B-12	Low Ta=-40°C±5°C Test Time=1,000hrs	0/22
	Temperature Cycling	MIL-STD-202:107D MIL-STD-750:1051 MIL-STD-883:1010 JIS-C-7021 :A-4	-40°C ~ +25°C ~ +85°C ~ +25°C 60min 20min 60min 20min Test Time=200cycle	0/22
Thermal Shock	MIL-STD-202:107D MIL-STD-750:1051 MIL-STD-883:1010	-40°C±5°C ~ +85°C±5°C 20min 20min Test Time=200cycle	0/22	

*Failure Criteria:

1. VF arise \geq 10%
2. IV decline \geq 30%
3. A failure is an LED that is open or shorted



HUEY JANN ELECTRONICS INDUSTRY CO., LTD.

No.27 Line 466 Sec.2,Canng-nan Rd. Wu-chi Town Taichung Shien, Taiwan, R.O.C.

TEL:+886-4-26393976 FAX:+886-4-26393125

TYPICAL ELECTRICAL OPTICAL CHARACTERISTICS CURVES

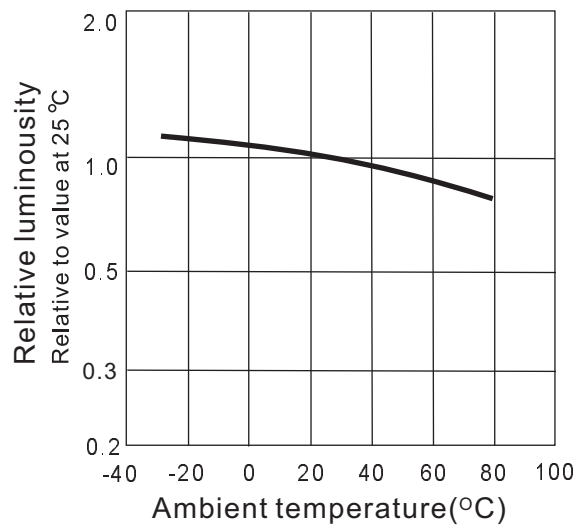
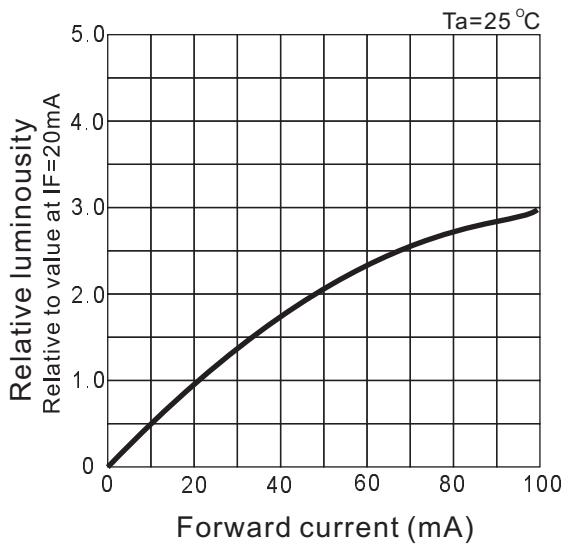
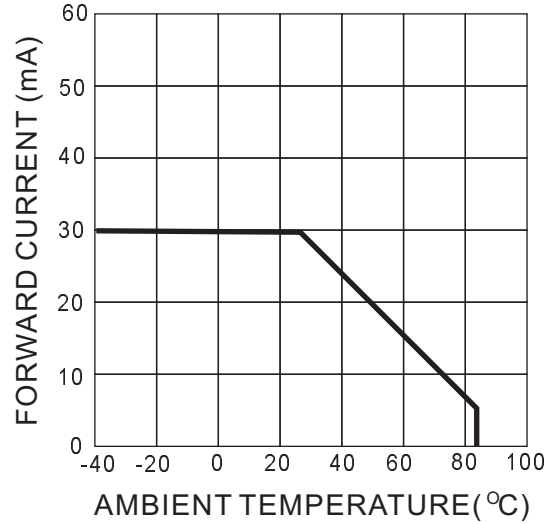
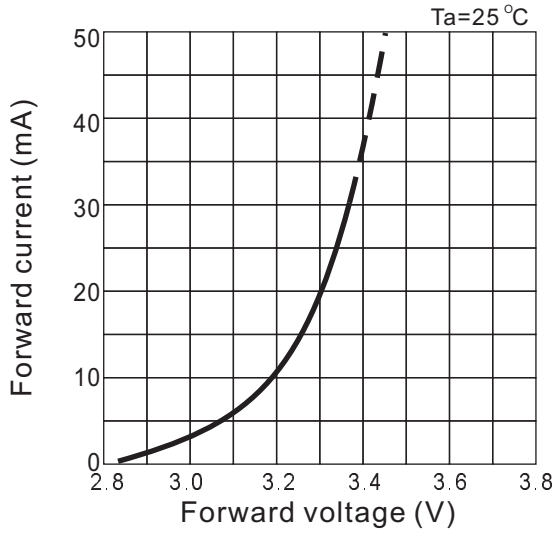

HUEY JANN ELECTRONICS INDUSTRY CO., LTD.

No.27 Line 466 Sec.2,Cannng-nan Rd. Wu-chi Town Taichung Shien, Taiwan, R.O.C.

TEL:+886-4-26393976 FAX:+886-4-26393125

TYPICAL ELECTRICAL OPTICAL CHARACTERISTICS CURVES

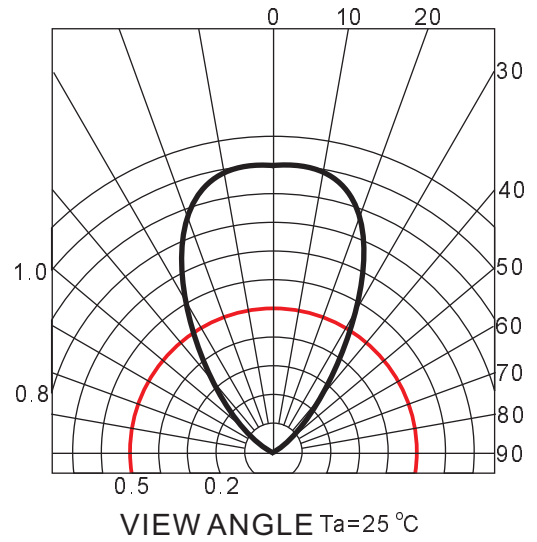
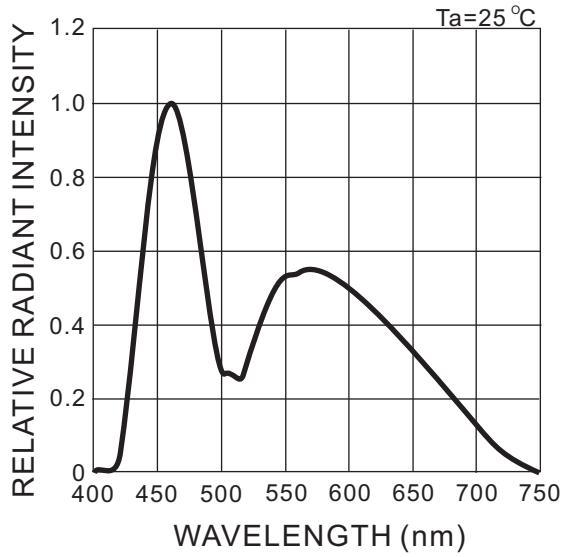

HUEY JANN ELECTRONICS INDUSTRY CO., LTD.

No.27 Line 466 Sec.2,Canng-nan Rd. Wu-chi Town Taichung Shien, Taiwan, R.O.C.

TEL:+886-4-26393976 FAX:+886-4-26393125

LED VF Bin Selection

$I_F=20\text{mA}$

BIN CODE	Forward Voltage	
	Minimum	Maximum
j	3.0	3.2
k	3.2	3.4
m	3.4	3.6
n	3.6	3.8

Voltage tolerance for each bin limit is $\pm 0.03\text{V}$

Brightness Code

$I_F=20\text{mA}$

BIN CODE	Brightness in mcd	
	Minimum	Maximum
T	2500	3200
U	3200	4200
V	4200	5500

Brightness tolerance for each bin limit is $\pm 15\%$



HUEY JANN ELECTRONICS INDUSTRY CO., LTD.

No.27 Line 466 Sec.2, Canning-nan Rd. Wu-chi Town Taichung Shien, Taiwan, R.O.C.

TEL:+886-4-26393976 FAX:+886-4-26393125

Color Bin Selection

If=20mA

Bin		Chromaticity Coordinates				Bin		Chromaticity Coordinates					
3	3-1	x	0.260	0.270	0.270	0.260	8	8-1	x	0.310	0.320	0.320	0.310
		y	0.280	0.290	0.270	0.260			y	0.330	0.340	0.320	0.310
	3-2	x	0.260	0.270	0.270	0.260		8-2	x	0.310	0.320	0.320	0.310
		y	0.260	0.270	0.240	0.230			y	0.310	0.320	0.290	0.280
4	4-1	x	0.270	0.280	0.280	0.270	9	9-1	x	0.320	0.330	0.330	0.320
		y	0.290	0.300	0.280	0.270			y	0.360	0.370	0.350	0.340
	4-2	x	0.270	0.280	0.280	0.270		9-2	x	0.320	0.330	0.330	0.320
		y	0.270	0.280	0.250	0.240			y	0.340	0.350	0.315	0.305
5	5-1	x	0.280	0.290	0.290	0.280	10	10-1	x	0.330	0.340	0.340	0.330
		y	0.300	0.310	0.290	0.280			y	0.370	0.380	0.360	0.350
	5-2	x	0.280	0.290	0.290	0.280		10-2	x	0.330	0.340	0.340	0.330
		y	0.280	0.290	0.260	0.250			y	0.350	0.360	0.325	0.315
6	6-1	x	0.290	0.300	0.300	0.250	11	11-1	x	0.340	0.350	0.350	0.340
		y	0.310	0.320	0.300	0.290			y	0.380	0.390	0.370	0.360
	6-2	x	0.250	0.300	0.300	0.290		11-2	x	0.340	0.350	0.350	0.340
		y	0.290	0.300	0.270	0.260			y	0.360	0.370	0.335	0.325
7	7-1	x	0.300	0.310	0.310	0.300	12	12-1	x	0.350	0.360	0.360	0.350
		y	0.320	0.330	0.310	0.300			y	0.390	0.400	0.380	0.370
	7-2	x	0.300	0.310	0.310	0.300		12-2	x	0.350	0.360	0.360	0.350
		y	0.300	0.310	0.280	0.270			y	0.370	0.380	0.345	0.335
Tolerance		x ± 0.02		y ± 0.02		Tolerance		x ± 0.02		y ± 0.02			

The chromaticity coordinates reading at center of light.



HUEY JANN ELECTRONICS INDUSTRY CO., LTD.

No.27 Line 466 Sec.2,Cann-g-nan Rd. Wu-chi Town Taichung Shien, Taiwan, R.O.C.

TEL:+886-4-26393976 FAX:+886-4-26393125

CIE Light Color Chart

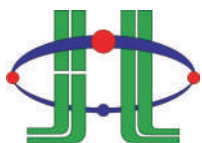
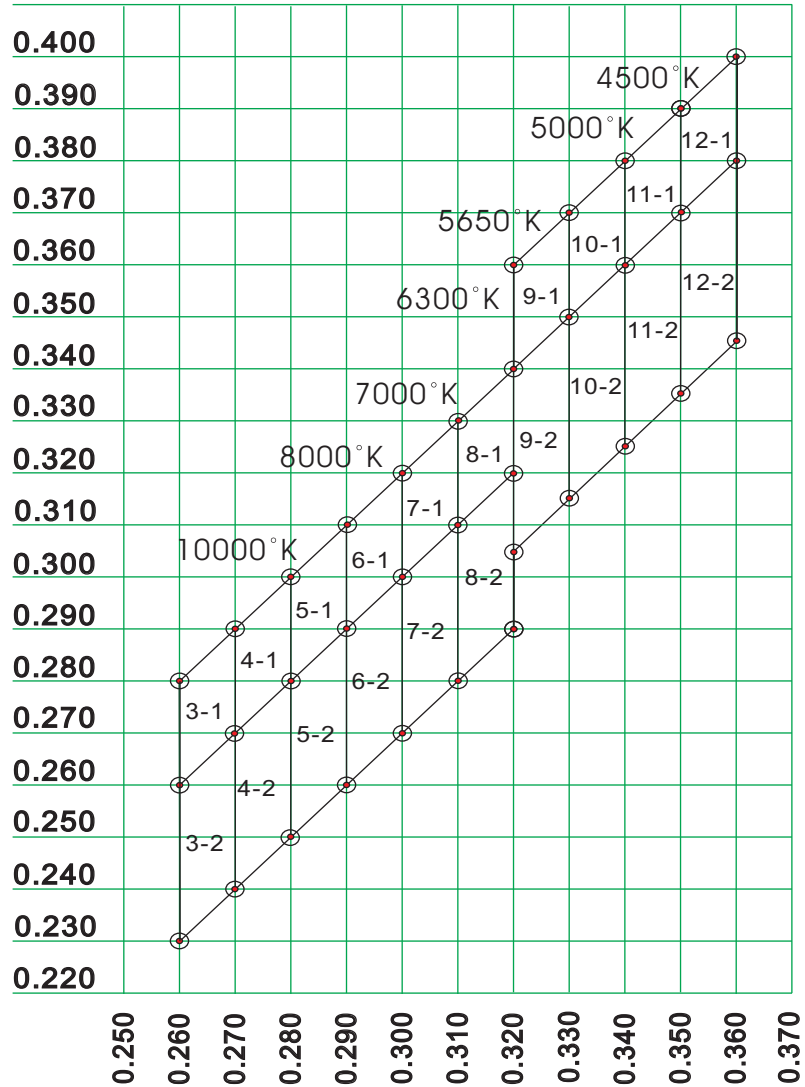

HUEY JANN ELECTRONICS INDUSTRY CO., LTD.

No.27 Line 466 Sec.2,Cannng-nan Rd. Wu-chi Town Taichung Shien, Taiwan, R.O.C.

TEL:+886-4-26393976 FAX:+886-4-26393125