

# VISIBLE LIGHT PRODUCTS SPECIFICATION

HTLB4a-47HA HA HA



Drawn by	Checked by	Approved by



DATE:2009/6/17

REV:B

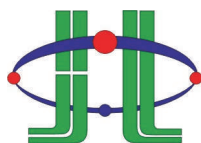

**HUEY JANN ELECTRONICS INDUSTRY CO., LTD.**

No.27 Line 466 Sec.2,Cannng-nan Rd. Wu-chi Town Taichung Shien, Taiwan, R.O.C.

TEL:+886-4-26393976 FAX:+886-4-26393125

DEVICES

Part Number	Lens		Source	
	Color	Diffusion	Dice Source	Color
HTLB4a-47HA HA HA	Water clear	Non-Diffused	AllnGaP/GaP	Super Amber

PACKAGE DIMENSIONS

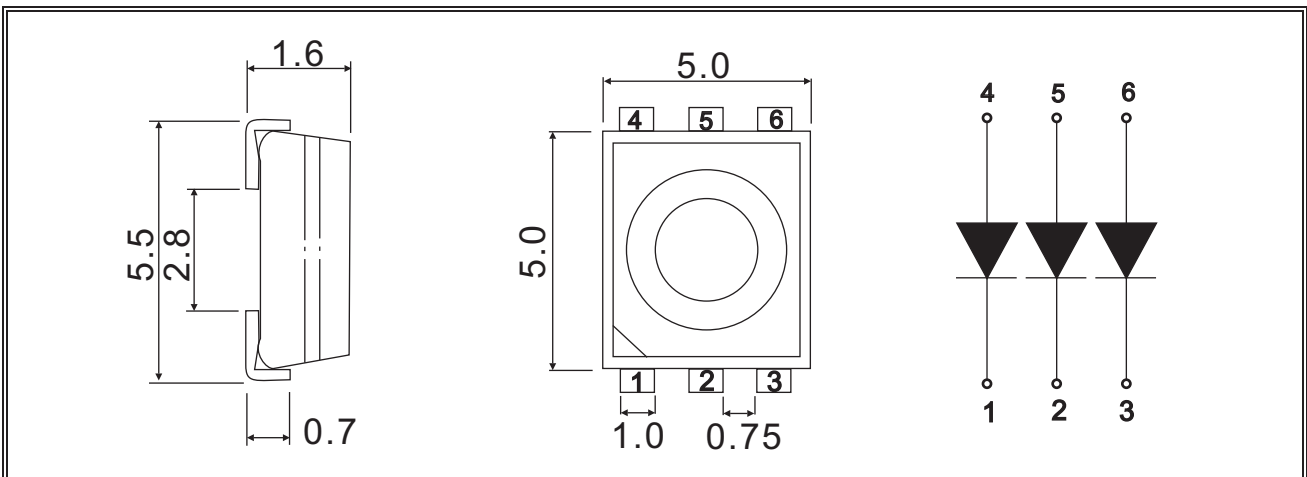

NOTE:

- 1.All dimensions are in millimeter.
- 2.specifications are subject to change without notice.
- 3.Tolerance is 0.3mm unless otherwise noted.

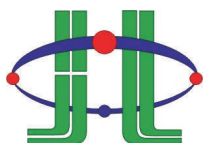

**HUEY JANN ELECTRONICS INDUSTRY CO., LTD.**

No.27 Line 466 Sec.2,Cannng-nan Rd. Wu-chi Town Taichung Shien, Taiwan, R.O.C.

TEL:+886-4-26393976 FAX:+886-4-26393125

RECOMMENDED SOLDERING PATTERN

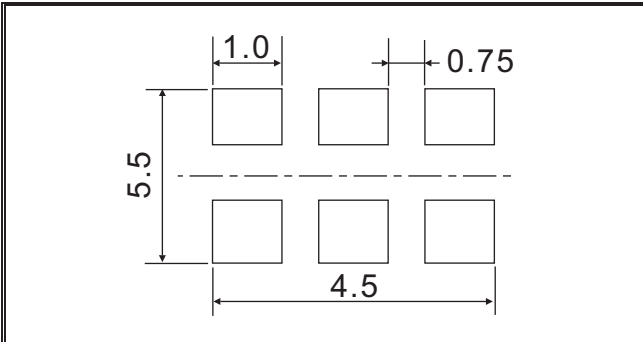

NOTE:

- 1.All dimensions are in millimeter.
- 2.specifications are subject to change without notice.

TAPE SPECIFICATIONS

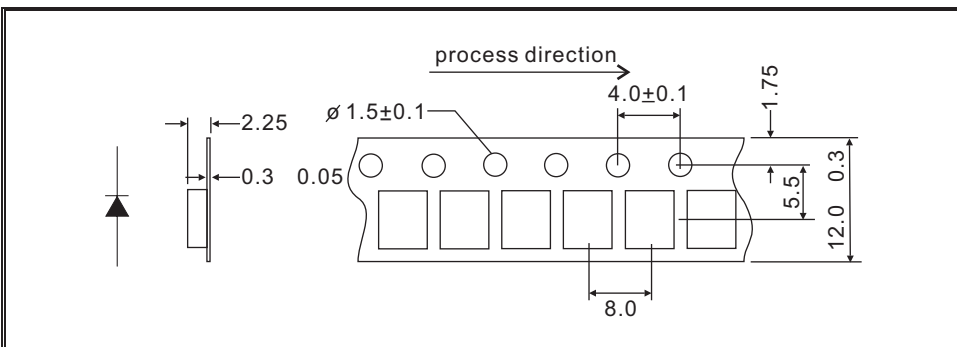

NOTE:

- 1.All dimensions are in millimeter.
- 2.specifications are subject to change without notice.

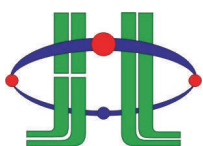

HUEY JANN ELECTRONICS INDUSTRY CO., LTD.

No.27 Line 466 Sec.2,Cannng-nan Rd. Wu-chi Town Taichung Shien, Taiwan, R.O.C.

TEL:+886-4-26393976 FAX:+886-4-26393125

ABSOLUTE MAXIMUM RATINGS

TA=25°C

PARAMETER	SYMBOL	MAX. RATING	UNIT
Power Dissipation	Pd	180	mW
Continuous Forward Current	IF	75	mA
Peak Forward Current *1	IFM	150	mA
Reverse Voltage	VR	5	V
LED Junction Temperature	Tj	100	°C
Operating Temperature	Topr	-40 ~ +85	°C
Storage Temperature	Tstg	-40 ~ +85	°C
Reflow Soldering (preheat 150-180°C 60-120sec, soldering temp 260°C 5sec)			

\*1.Duty Ratio=0.1%,Pulse Width=10us.

\*2.Iron soldering in 350°C within 5 seconds will not cause damage to the dice. But be aware of the high temperature will not only make the epoxy soften but also cause the lead moving and the gold wire broken and even open. So before returning to the normal temperature PLEASE AVOID any serious pressure on the top of epoxy and lead.

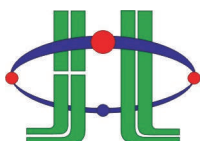

**HUEY JANN ELECTRONICS INDUSTRY CO., LTD.**

No.27 Line 466 Sec.2,Cannng-nan Rd. Wu-chi Town Taichung Shien, Taiwan, R.O.C.

TEL:+886-4-26393976 FAX:+886-4-26393125

ELECTRIC-OPTICAL CHARACTERISTICS

TA=25°C

PARAMETER	SYMBOL	TEST CONDITION	MIN	TYP	MAX	UNIT
View Angle of Half Power	2θ1/2	IF=60mA		120		deg
Forward Voltage	VF			2.1	2.4	V
Reverse Current	IR	VR=5V			10	μA
Luminous Intensity *2	IV	IF=60mA	1300	2500		mcd
Peak Emission Wavelength	λp			607		nm
Dominate Wave Length *3	λd(HUE)			605		nm
Spectrum Width Of Half Valve	Δλ			20		nm

\*2.Tolerance: 15% HUEY-JANN measuring equipment : EXELTRON 2001. 2.S370 made by U.D.T.

\*3.The dominate wavelength , λ d, is derived from the CIE Chromaticity Diagram and represents the color of the device.

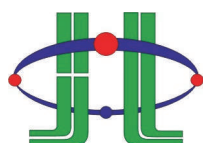

**HUEY JANN ELECTRONICS INDUSTRY CO., LTD.**

No.27 Line 466 Sec.2,Cannng-nan Rd. Wu-chi Town Taichung Shien, Taiwan, R.O.C.

TEL:+886-4-26393976 FAX:+886-4-26393125

RELIABILITY TEST

Classification	Test Item	Test Conditions	Refer to Temperature-profile
Reflow Soldering	Lead Solder	Pre-heat=120~150°C Pre-heat time=120sec Max Peak temperature=240°C Max Soldering time=10sec Max	
	Lead free Solder	Pre-heat=180~200°C Pre-heat time=120sec Max Peak temperature=260°C Max Soldering time=10sec Max	
Hand Soldering	Temperature=350°C Max Soldering time=3sec Max(one time only)		

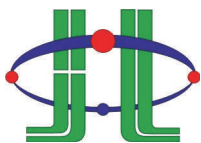

**HUEY JANN ELECTRONICS INDUSTRY CO., LTD.**

No.27 Line 466 Sec.2, Canning-nan Rd. Wu-chi Town Taichung Shien, Taiwan, R.O.C.

TEL:+886-4-26393976 FAX:+886-4-26393125

TYPICAL ELECTRICAL OPTICAL CHARACTERISTICS CURVES

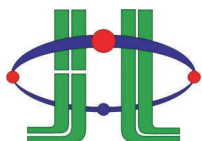
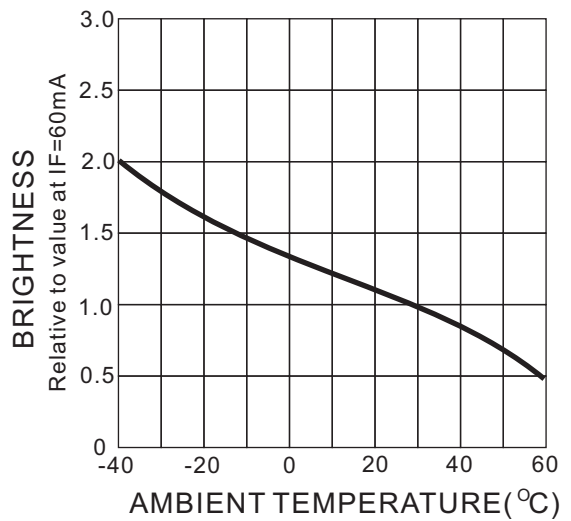
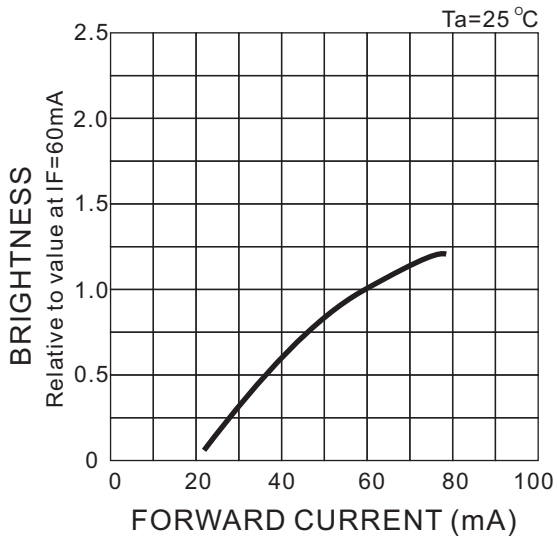
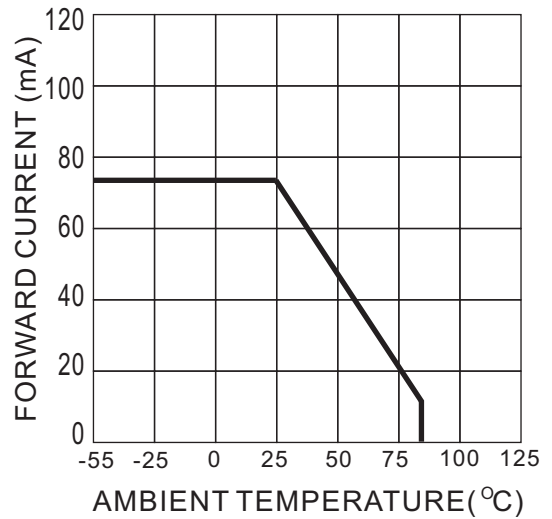
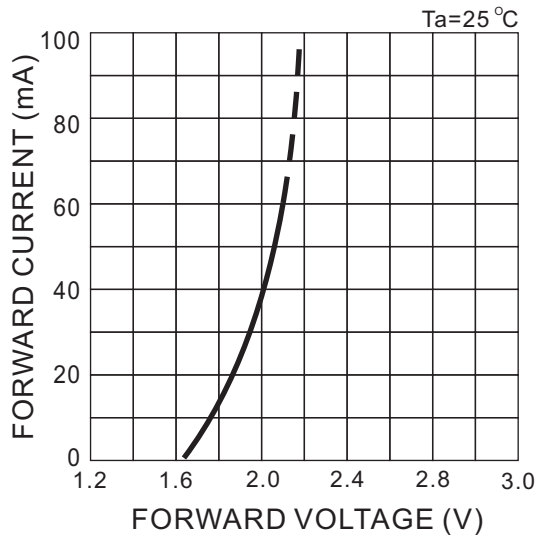

**HUEY JANN ELECTRONICS INDUSTRY CO., LTD.**

No.27 Line 466 Sec.2,Cannng-nan Rd. Wu-chi Town Taichung Shien, Taiwan, R.O.C.

TEL:+886-4-26393976 FAX:+886-4-26393125

TYPICAL ELECTRICAL OPTICAL CHARACTERISTICS CURVES

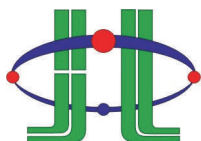
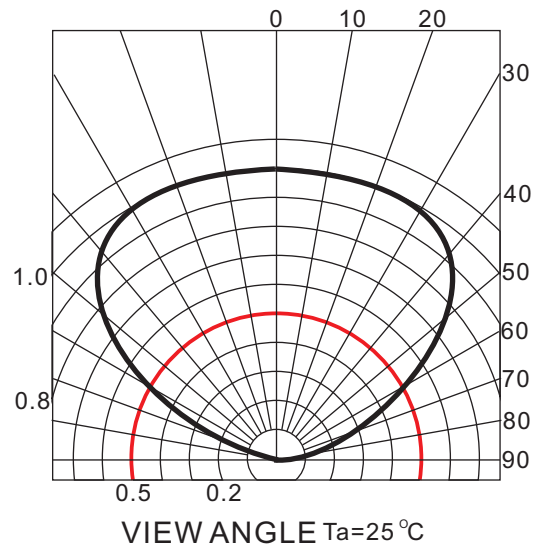
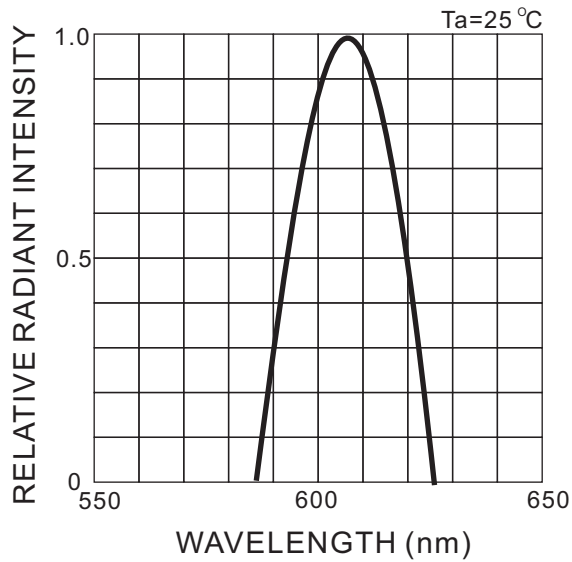

**HUEY JANN ELECTRONICS INDUSTRY CO., LTD.**

No.27 Line 466 Sec.2,Canng-nan Rd. Wu-chi Town Taichung Shien, Taiwan, R.O.C.

TEL:+886-4-26393976 FAX:+886-4-26393125

LED VF Bin Selection

$I_F=60\text{mA}$

BIN CODE	Forward Voltage	
	Minimum	Maximum
d	1.8	2.0
e	2.0	2.2
f	2.2	2.4

Voltage tolerance for each bin limit is  $\pm 0.03\text{V}$

Brightness Bin Selection

$I_F=60\text{mA}$

BIN CODE	Brightness in mcd	
	Minimum	Maximum
R	1500	1900
S	1900	2500
T	2500	3200
U	3200	4200

Brightness tolerance for each bin limit is  $\pm 15\%$

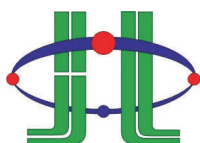

**HUEY JANN ELECTRONICS INDUSTRY CO., LTD.**

No.27 Line 466 Sec.2,Canng-nan Rd. Wu-chi Town Taichung Shien, Taiwan, R.O.C.

TEL:+886-4-26393976 FAX:+886-4-26393125