

# VISIBLE LIGHT PRODUCTS SPECIFICATION

## HMIB-48ABD



| Drawn by | Checked by | Approved by |
|----------|------------|-------------|
|          |            |             |
|          |            |             |



DATE:2008/11/13

REV:F



**HUEY JANN ELECTRONICS INDUSTRY CO., LTD.**

No.27 Line 466 Sec.2,Cannng-nan Rd. Wu-chi Town Taichung Shien, Taiwan, R.O.C.

TEL:+886-4-26393976 FAX:+886-4-26393125

DEVICES

| Part Number | Lens        |              | Source      |            |
|-------------|-------------|--------------|-------------|------------|
|             | Color       | Diffusion    | Dice Source | Color      |
| HMIB-48ABD  | Water clear | Non-Diffused | GaN/GaIn    | Super Blue |

PACKAGE DIMENSIONS

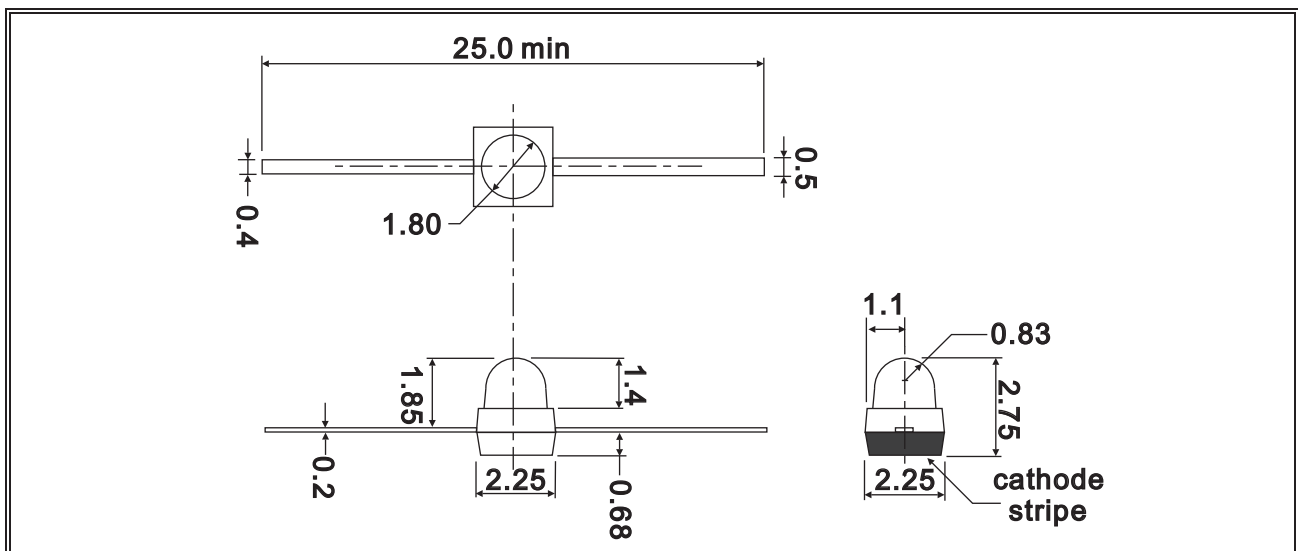

NOTE:

- 1.All dimensions are in millimeter.
- 2.specifications are subject to change without notice.
- 3.Tolerance is  $\pm 0.3$ mm unless otherwise noted.

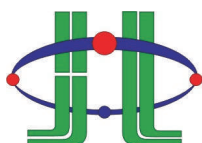

**HUEY JANN ELECTRONICS INDUSTRY CO., LTD.**

No.27 Line 466 Sec.2,Cannng-nan Rd. Wu-chi Town Taichung Shien, Taiwan, R.O.C.

TEL:+886-4-26393976 FAX:+886-4-26393125

ABSOLUTE MAXIMUM RATINGS

TA=25°C

| PARAMETER  | SYMBOL | MAX. RATING | UNIT |
|--|--------|-------------|------|
| Power Dissipation                                | Pd     | 120         | mW   |
| Continuous Forward Current                       | IF     | 25          | mA   |
| Peak Forward Current *1                          | IFM    | 100         | mA   |
| Reverse Voltage                                  | VR     | 4           | V    |
| Electrostatic Discharge (HBM)                    | ESD    | 150         | V    |
| LED Junction Temperature                         | Tj     | 100         | °C   |
| Operating Temperature                            | Topr   | -40 ~ +85   | °C   |
| Storage Temperature                              | Tstg   | -40 ~ +100  | °C   |
| Dip Soldering Temperature (260 °C for 3 seconds) |        |             |      |

\*1.Duty Ratio=0.1%,Pulse Width=10us.

\*2.Iron soldering in 350°C within 5 seconds will not cause damage to the dice. But be aware of the high temperature will not only make the epoxy soften but also cause the lead moving and the gold wire broken and even open. So before returning to the normal temperature PLEASE AVOID any serious pressure on the top of epoxy and lead.

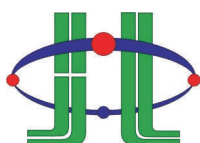

**HUEY JANN ELECTRONICS INDUSTRY CO., LTD.**

No.27 Line 466 Sec.2,Cannng-nan Rd. Wu-chi Town Taichung Shien, Taiwan, R.O.C.

TEL:+886-4-26393976 FAX:+886-4-26393125

ELECTRIC-OPTICAL CHARACTERISTICS

TA=25°C

| PARAMETER                    | SYMBOL  | TEST CONDITION | MIN | TYP  | MAX | UNIT |
|------------------------------|---------|----------------|-----|------|-----|------|
| View Angle of Half Power     | 2θ1/2   | IF=20mA        |     | 24   |     | deg  |
| Forward Voltage              | VF      |                |     | 3.3  | 3.8 | V    |
| Reverse Current              | IR      | VR=4V          |     |      | 60  | μA   |
| Luminous Intensity *2        | IV      | IF=20mA        | 800 | 1800 |     | mcd  |
| Peak Emission Wavelength     | λp      |                |     | 462  |     | nm   |
| Dominate Wave Length *3      | λd(HUE) |                |     | 465  |     | nm   |
| Spectrum Width Of Half Valve | Δλ      |                |     | 35   |     | nm   |
| Terminal Capacitance         | Ct      | V=0V<br>F=1MHz |     | 18   |     | pF   |

\*2.Tolerance:±15% HUEY-JANN measuring equipment : EXELTRON 2001. 2.S370 made by U.D.T.

\*3.The dominate wavelength , λ d, is derived from the CIE Chromaticity Diagram and represents the color of the device.

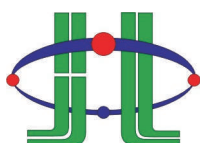

**HUEY JANN ELECTRONICS INDUSTRY CO., LTD.**

No.27 Line 466 Sec.2,Cannng-nan Rd. Wu-chi Town Taichung Shien, Taiwan, R.O.C.

TEL:+886-4-26393976 FAX:+886-4-26393125

RELIABILITY TEST

| Classification | Test Item  | Reference Standard  | Test Conditions   | Result |
|----------------|--|---|---|--------|
| Endurance Test | Operation Life   | MIL-STD-750:1026<br>MIL-STD-883:1005<br>JIS-C-7021 :B-1                     | Connect with a power if=20mA<br>Ta=Under room temperature<br>Test Time=1,000hrs | 0/22   |
|                | High Temperature High Humidity Storage                   | MIL-STD-202:103B<br>JIS-C-7021 :B-11  | Ta=+85°C±5°C<br>RH=90% ~ 95%<br>Test Time=1000hrs                               | 0/22   |
|                | High Temperature Storage                                 | MIL-STD-883:1008<br>JIS-C-7021 :B-10  | High Ta=+100°C±5°C<br>Test Time=1,000hrs  | 0/22   |
|                | Low Temperature Storage                                  | JIS-C-7021 :B-12  | Low Ta=-40°C±5°C<br>Test Time=1,000hrs  | 0/22   |
|                | Temperature Cycling                                      | MIL-STD-202:107D<br>MIL-STD-750:1051<br>MIL-STD-883:1010<br>JIS-C-7021 :A-4 | -40°C ~ +25°C ~ +85°C ~ +25°C<br>60min 20min 60min 20min<br>Test Time=200cycle  | 0/22   |
| Thermal Shock  | MIL-STD-202:107D<br>MIL-STD-750:1051<br>MIL-STD-883:1010 | -40°C±5°C ~ +85°C±5°C<br>20min 20min<br>Test Time=200cycle                  | 0/22  |        |

\*Failure Criteria:

1. VF arise  $\geq 10\%$
2. IV decline  $\geq 30\%$
3. A failure is an LED that is open or shorted



**HUEY JANN ELECTRONICS INDUSTRY CO., LTD.**

No.27 Line 466 Sec.2,Canng-nan Rd. Wu-chi Town Taichung Shien, Taiwan, R.O.C.

TEL:+886-4-26393976 FAX:+886-4-26393125

TYPICAL ELECTRICAL OPTICAL CHARACTERISTICS CURVES

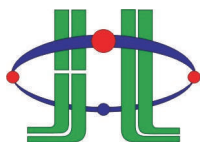
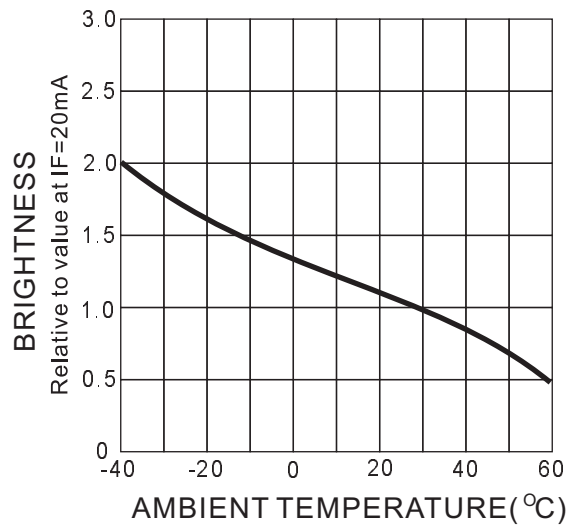
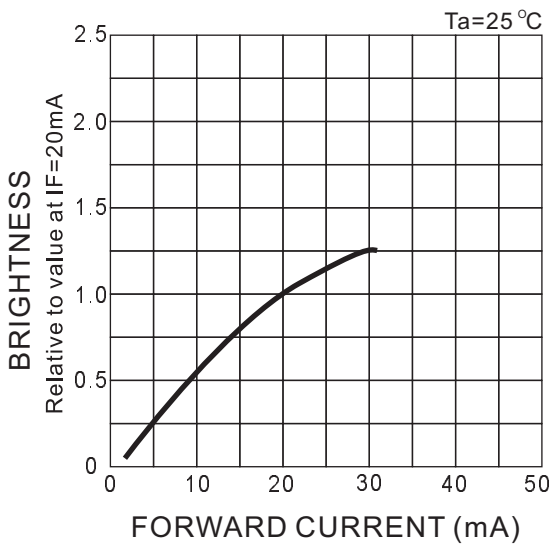
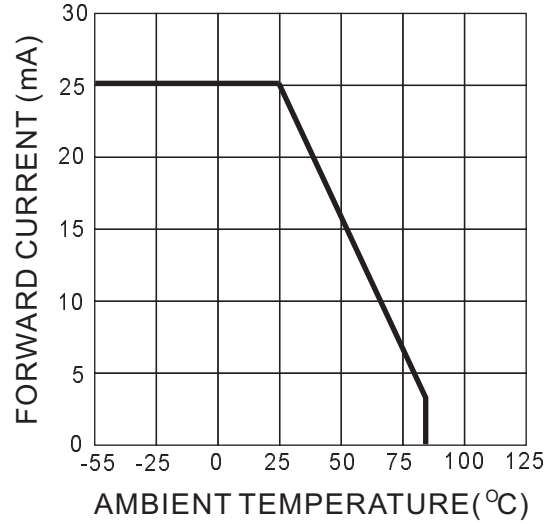
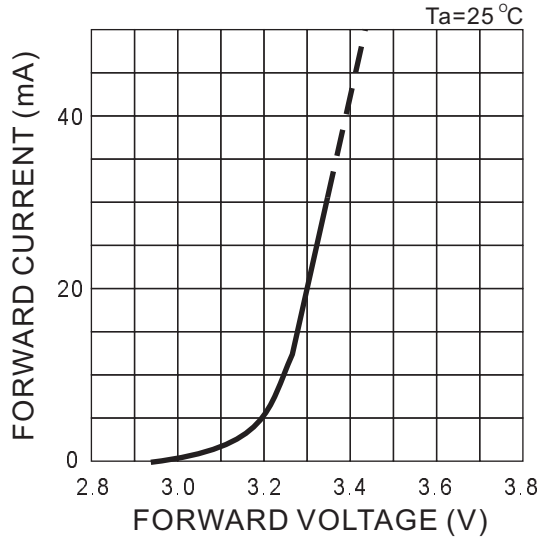

**HUEY JANN ELECTRONICS INDUSTRY CO., LTD.**

No.27 Line 466 Sec.2,Cannng-nan Rd. Wu-chi Town Taichung Shien, Taiwan, R.O.C.

TEL:+886-4-26393976 FAX:+886-4-26393125

TYPICAL ELECTRICAL OPTICAL CHARACTERISTICS CURVES

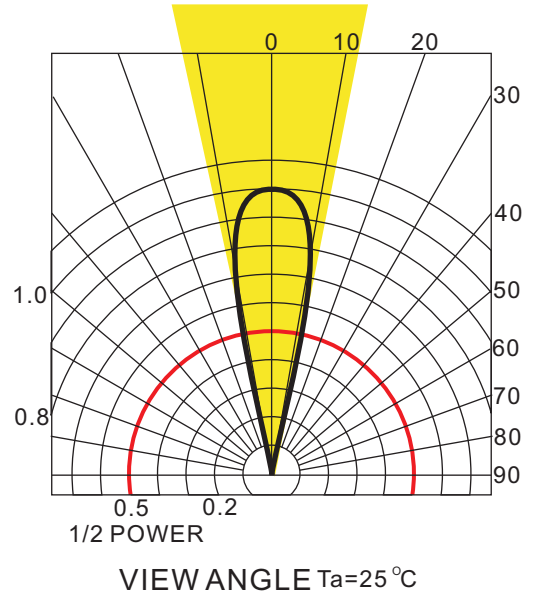
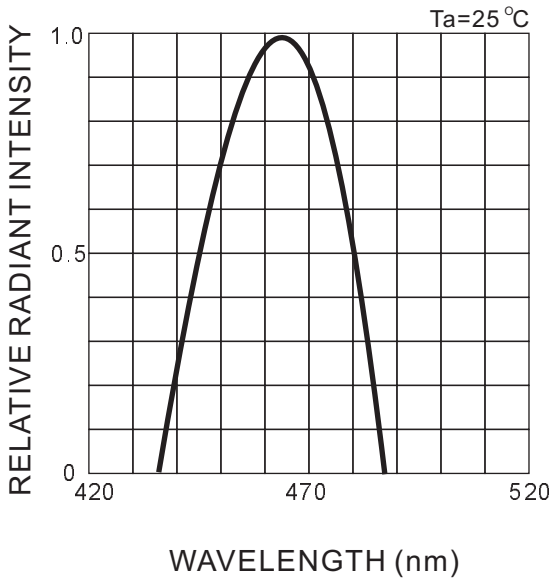

**HUEY JANN ELECTRONICS INDUSTRY CO., LTD.**

No.27 Line 466 Sec.2,Cannng-nan Rd. Wu-chi Town Taichung Shien, Taiwan, R.O.C.

TEL:+886-4-26393976 FAX:+886-4-26393125