

VISIBLE LIGHT PRODUCTS SPECIFICATION

HTLB4-45AOR8ABD



Drawn by	Checked by	Approved by



DATE:2009/5/4

REV:B



HUEY JANN ELECTRONICS INDUSTRY CO., LTD.

No.27 Line 466 Sec.2,Cannng-nan Rd. Wu-chi Town Taichung Shien, Taiwan, R.O.C.

TEL:+886-4-26393976 FAX:+886-4-26393125

DEVICES

Part Number	Lens		Source	
	Color	Diffusion	Dice Source	Color
HTLB4-45AOR8ABD	Water clear	Non-Diffused	AllInGaP/GaAs & GaInN/GaN	Super blue & Super Fresh Red

PACKAGE DIMENSIONS

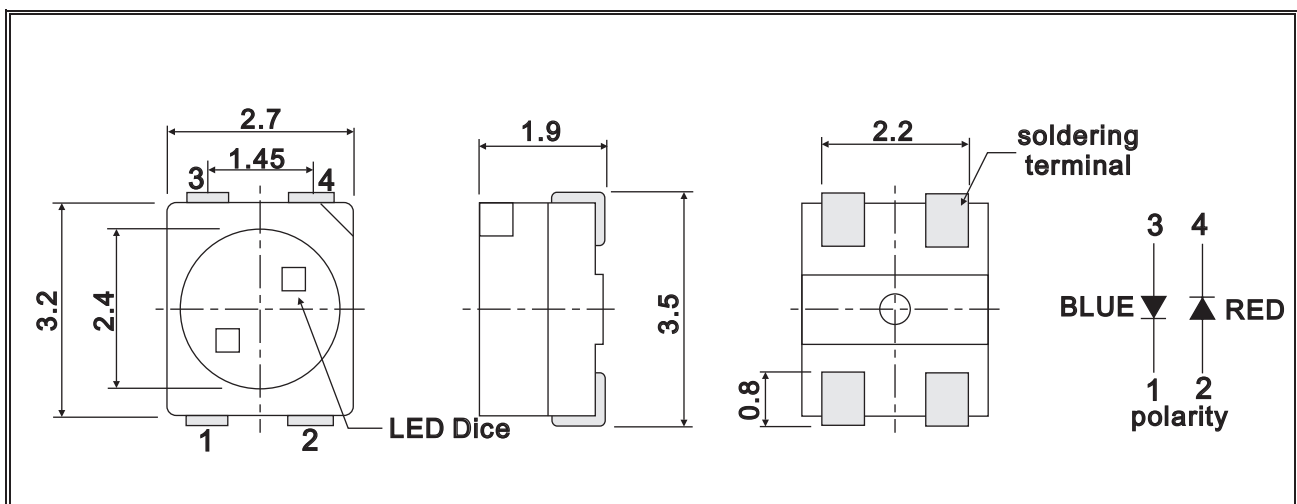

NOTE:

- 1.All dimensions are in millimeter.
- 2.specifications are subject to change without notice.
- 3.Tolerance is $\pm 0.3\text{mm}$ unless otherwise noted.

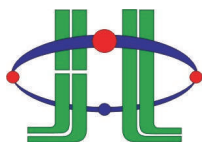

HUEY JANN ELECTRONICS INDUSTRY CO., LTD.

No.27 Line 466 Sec.2,Cannng-nan Rd. Wu-chi Town Taichung Shien, Taiwan, R.O.C.

TEL:+886-4-26393976 FAX:+886-4-26393125

RECOMMENDED SOLDERING PATTERN

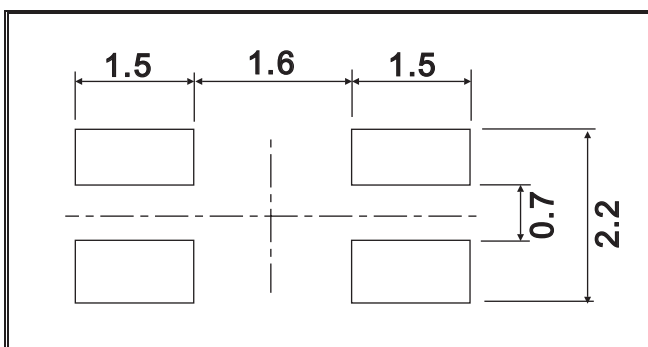

NOTE:

- 1.All dimensions are in millimeter.
- 2.specifications are subject to change without notice.

TAPE SPECIFICATIONS

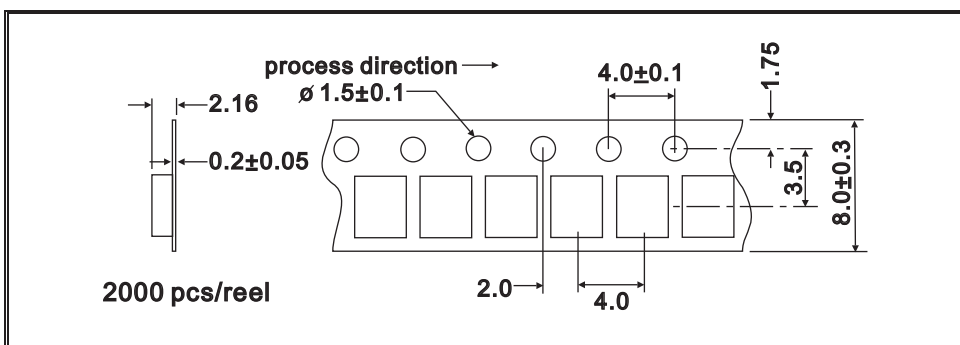

NOTE:

- 1.All dimensions are in millimeter.
- 2.specifications are subject to change without notice.

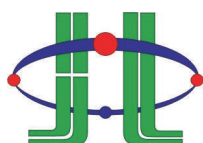

HUEY JANN ELECTRONICS INDUSTRY CO., LTD.

No.27 Line 466 Sec.2,Cannng-nan Rd. Wu-chi Town Taichung Shien, Taiwan, R.O.C.

TEL:+886-4-26393976 FAX:+886-4-26393125

ABSOLUTE MAXIMUM RATINGS

TA=25°C

PARAMETER	SYMBOL	MAX. RATING		UNIT
		Super Fresh Red	Super Blue	
Power Dissipation	Pd	100	120	mW
Continuous Forward Current	IF	25	20	mA
Peak Forward Current *1	IFM	50	100	mA
Reverse Voltage	VR	5	4	V
LED Junction Temperature	Tj	100		°C
Operating Temperature	Topr	-40 ~ +85		°C
Storage Temperature	Tstg	-40 ~ +85		°C
Reflow Soldering (preheat 150-180°C 60-120sec, soldering temp 260°C 5sec)				

*1.Duty Ratio=0.1%,Pulse Width=10us.

*2.Iron soldering in 350°C within 5 seconds will not cause damage to the dice. But be aware of the high temperature will not only make the epoxy soften but also cause the lead moving and the gold wire broken and even open. So before returning to the normal temperature PLEASE AVOID any serious pressure on the top of epoxy and lead.

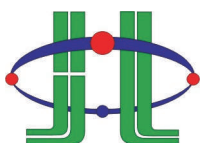

HUEY JANN ELECTRONICS INDUSTRY CO., LTD.

No.27 Line 466 Sec.2,Cannng-nan Rd. Wu-chi Town Taichung Shien, Taiwan, R.O.C.

TEL:+886-4-26393976 FAX:+886-4-26393125

ELECTRIC-OPTICAL CHARACTERISTICS

TA=25°C

PARAMETER	SYMBOL	TEST CONDITION	MIN	TYP	MAX	UNIT	
View Angle of Half Power	2θ1/2	IF=20mA	Red		120		deg
			Blue				
Forward Voltage	VF		Red		2.0	2.5	V
			Blue		3.3	3.8	
Luminous Intensity *2	IV		Red	120	210		mcd
			Blue	90	180		
Peak Emission Wavelength	λ p		Red		635		nm
			Blue		468		
Spectrum Width of Half Valve	λ d(HUE)	Red		25		nm	
		Blue		35			

*2.Tolerance:±15% HUEY-JANN measuring equipment : EXELTRON 2001. 2.S370 made by U.D.T.

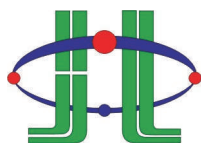

HUEY JANN ELECTRONICS INDUSTRY CO., LTD.

No.27 Line 466 Sec.2,Cannng-nan Rd. Wu-chi Town Taichung Shien, Taiwan, R.O.C.

TEL:+886-4-26393976 FAX:+886-4-26393125

RELIABILITY TEST

Classification	Test Item	Reference Standard	Test Conditions	Result
Endurance Test	Operation Life	MIL-STD-750:1026 MIL-STD-883:1005 JIS-C-7021 :B-1	Connect with a power if=20mA Ta=Under room temperature Test Time=1,000hrs	0/22
	High Temperature High Humidity Storage	MIL-STD-202:103B JIS-C-7021 :B-11	Ta=+85°C±5°C RH=90% ~ 95% Test Time=1000hrs	0/22
	High Temperature Storage	MIL-STD-883:1008 JIS-C-7021 :B-10	High Ta=+85°C±5°C Test Time=1,000hrs	0/22
	Low Temperature Storage	JIS-C-7021 :B-12	Low Ta=-40°C±5°C Test Time=1,000hrs	0/22
Environmental Test	Temperature Cycling	MIL-STD-202:107D MIL-STD-750:1051 MIL-STD-883:1010 JIS-C-7021 :A-4	-40°C ~ +25°C ~ +85°C ~ +25°C 60min 20min 60min 20min Test Time=200cycle	0/22
	Thermal Shock	MIL-STD-202:107D MIL-STD-750:1051 MIL-STD-883:1010	-40°C±5°C ~ +85°C±5°C 20min 20min Test Time=200cycle	0/22

*Failure Criteria:

1. VF arise $\geq 10\%$
2. IV decline $\geq 30\%$
3. A failure is an LED that is open or shorted

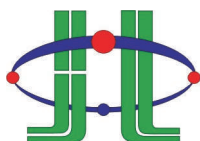

HUEY JANN ELECTRONICS INDUSTRY CO., LTD.

No.27 Line 466 Sec.2,Cannng-nan Rd. Wu-chi Town Taichung Shien, Taiwan, R.O.C.

TEL:+886-4-26393976 FAX:+886-4-26393125

TYPICAL ELECTRICAL OPTICAL CHARACTERISTICS CURVES

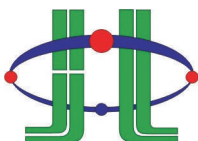
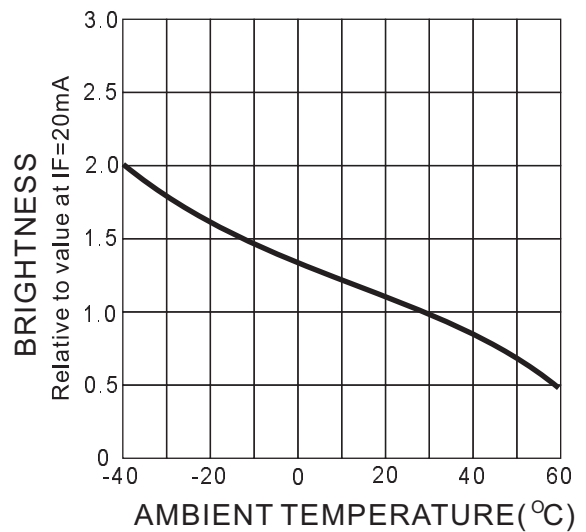
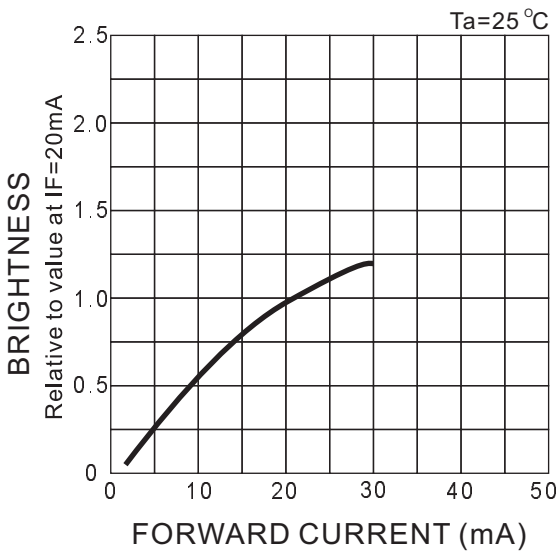
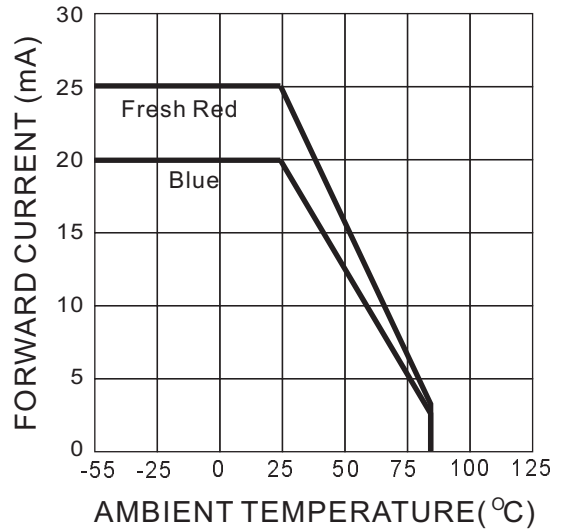
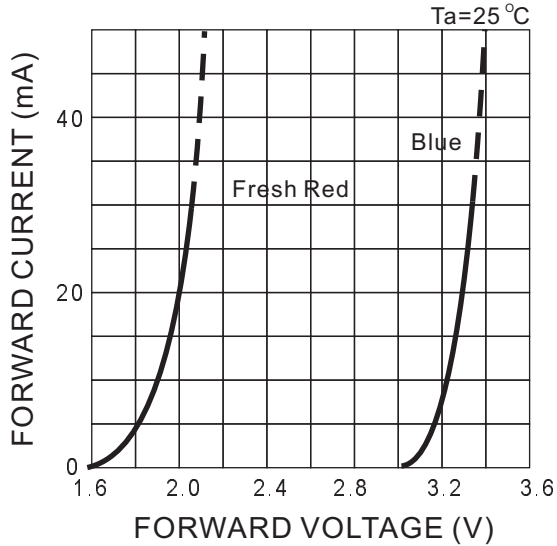

HUEY JANN ELECTRONICS INDUSTRY CO., LTD.

No.27 Line 466 Sec.2,Cannng-nan Rd. Wu-chi Town Taichung Shien, Taiwan, R.O.C.

TEL:+886-4-26393976 FAX:+886-4-26393125

TYPICAL ELECTRICAL OPTICAL CHARACTERISTICS CURVES

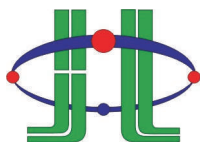
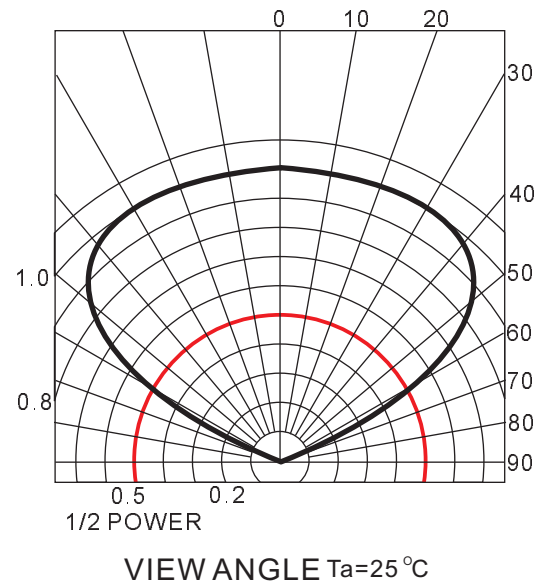
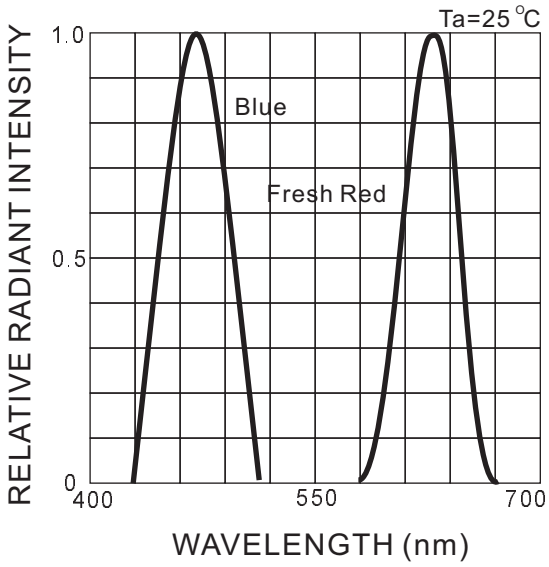

HUEY JANN ELECTRONICS INDUSTRY CO., LTD.

No.27 Line 466 Sec.2,Canng-nan Rd. Wu-chi Town Taichung Shien, Taiwan, R.O.C.

TEL:+886-4-26393976 FAX:+886-4-26393125