

High Power 50W LED Module

IF=1750mA Ta=25°C

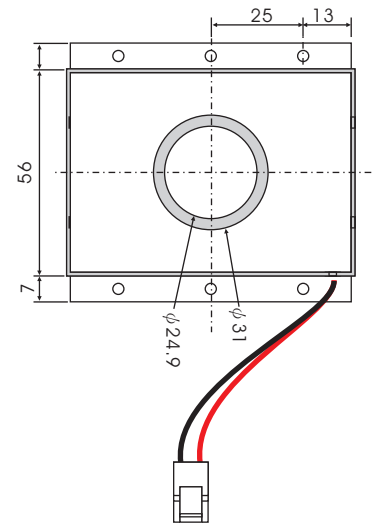

Device No	Color		Wavelength(nm)		VF	Brightness(lm)	View
	Emitter	Lens	λ_p	λ_d	Typical (V)	IV	Angle 2 θ 1/2

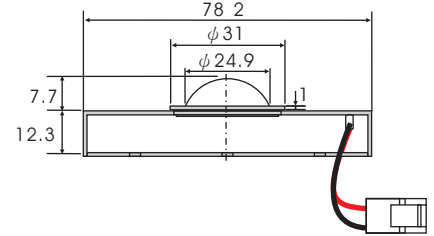
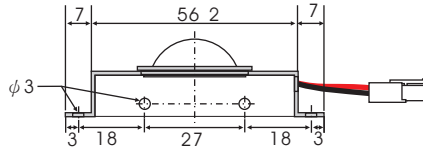
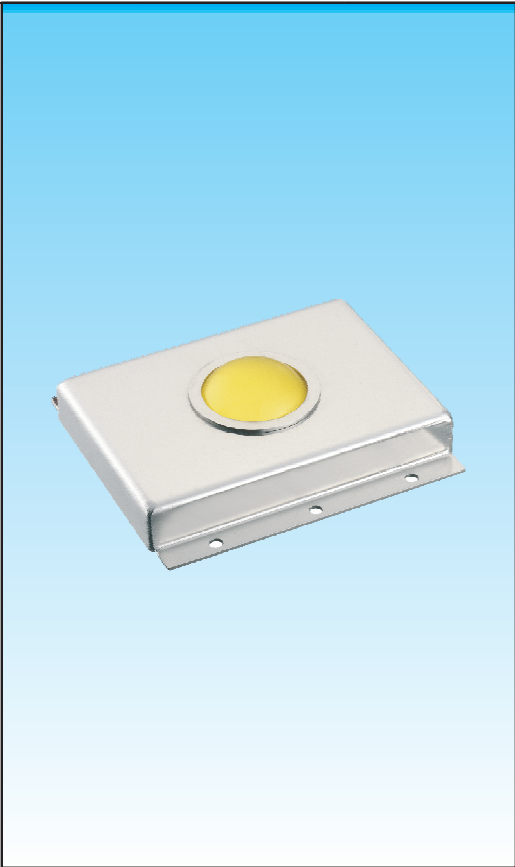

UNIT:mm

HPBM-19K50BW	Cool White	Yellow diffused	8000°K	28	3250	120
HPBM-19K50BWG	Cool White		8000°K	27	3735	
HPBM-19K50W	Pure White		6000°K	28	3250	
HPBM-19K50WG	Pure White		6000°K	27	3735	
HPBM-19K50NW	Nature White		4000°K	28	3175	
HPBM-19K50NWG	Nature White		4000°K	27	3650	
HPBM-19K50NW/CRI 90	Nature White		4000°K	28	2620	
HPBM-19K50NWG/CRI 90	Nature White		4000°K	27	3010	